

CK65 Mobile Computer - Configuration Guide

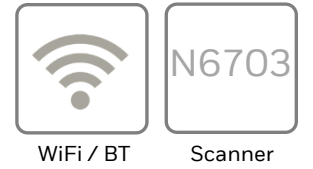

- Included in the box:
- CK65 Mobile Computer
 - Battery
 - Hand strap

(Stylus is not included, but available to order separately as an accessory)



N6703 Standard Range (SR)



CK65 Alphanumeric – N6703 SR – No Camera – 2GB RAM/ 32GB Flash

CK65-LON-ASN210x

CK65, Alphanumeric, Android GMS, 2x2 MIMO 802.11 a/b/g/n/ac/r/k/mc, 1D/2D Imager SR (N6703), 2GB/32GB Memory, No Camera, BT 5.0, NFC

CK65 Numeric F-Key – N6703 SR – No Camera – 2GB RAM/ 32GB Flash

CK65-LON-CSN210x

CK65, Numeric F-Key, Android GMS, 2x2 MIMO 802.11 a/b/g/n/ac/r/k/mc, 1D/2D Imager SR (N6703), 2GB/32GB Memory, No Camera, BT 5.0, NFC

CK65 Alphanumeric – N6703 SR – 13MP Camera – 4GB RAM/ 32GB Flash

CK65-LON-BSC210x

CK65, Alphanumeric, Android GMS, 2x2 MIMO 802.11 a/b/g/n/ac/r/k/mc, 1D/2D Imager SR (N6703), 4GB/32GB Memory, 13MP Camera, BT 5.0, NFC

CK65 Numeric F-Key – N6703 SR – 13MP Camera – 4GB RAM/ 32GB Flash

CK65-LON-DSC210x

CK65, Numeric F-Key, Android GMS, 2x2 MIMO 802.11 a/b/g/n/ac/r/k/mc, 1D/2D Imager SR (N6703), 4GB/32GB Memory, 13MP Camera, BT 5.0, NFC

(Note: x = Domain, select appropriate Domain from Configuration Map on page 9)

Honeywell Repair Services

SVCCCK65-5FC3

CK65, PLUS, 5 Day Turnaround, 3 Year, Day One

CK65 Mobile Computer - Configuration Guide



EX20 Near/ Far



Alphanumeric (51-Key)

Numeric F-Key (38-Key)

Large Numeric (30-Key)

CK65 Alphanumeric – EX20 Near/ Far – No Camera – 2GB RAM/ 32GB Flash

CK65-LON-AMN210x CK65, Alphanumeric, Android GMS, 2x2 MIMO 802.11 a/b/g/n/ac/r/k/mc, 1D/2D Near/Far Imager (EX20), 2GB/32GB Memory, No Camera, BT 5.0, NFC

CK65 Numeric F-Key – EX20 Near/ Far – No Camera – 2GB RAM/ 32GB Flash

CK65-LON-CMN210x CK65, Numeric F-Key, Android GMS, 2x2 MIMO 802.11 a/b/g/n/ac/r/k/mc, 1D/2D Near/Far Imager (EX20), 2GB/32GB Memory, No Camera, BT 5.0, NFC

(Note: x = Domain, select appropriate Domain from Configuration Map on page 9)

Honeywell Repair Services

SVCCCK65-5FC3

CK65, PLUS, 5 Day Turnaround, 3 Year, Day One

CK65 Alphanumeric – EX20 Near/ Far – 13MP Camera – 4GB RAM/ 32GB Flash

CK65-LON-BMC210x CK65, Alphanumeric, Android GMS, 2x2 MIMO 802.11 a/b/g/n/ac/r/k/mc, 1D/2D Near/Far Imager (EX20), 4GB/32GB Memory, 13MP Camera, BT 5.0, NFC

CK65 Numeric F-Key – EX20 Near/ Far – 13MP Camera – 4GB RAM/ 32GB Flash

CK65-LON-DMC210x CK65, Numeric F-Key, Android GMS, 2x2 MIMO 802.11 a/b/g/n/ac/r/k/mc, 1D/2D Near/Far Imager (EX20), 4GB/32GB Memory, 13MP Camera, BT 5.0, NFC

CK65 Large Numeric – EX20 Near/ Far – 13MP Camera – 4GB RAM/ 32GB Flash

CK65-LON-EMC214x CK65, Large Numeric, Android GMS, 2x2 MIMO 802.11 a/b/g/n/ac/r/k/mc, 1D/2D Near/Far Imager (EX20), 4GB/32GB Memory, 13MP Camera, BT 5.0, NFC

- Included in the box:
- CK65 Mobile Computer
 - Battery
 - Hand strap
- (Stylus is not included, but available to order separately as an accessory)

CK65 Mobile Computer - Configuration Guide

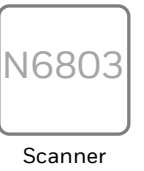

Alphanumeric (51-Key)



Numeric F-Key (38-Key)



Large Numeric (30-Key)



N6803 FlexRange™ (FR)



- Included in the box:
- CK65 Mobile Computer
 - Battery
 - Hand strap

(Stylus is not included, but available to order separately as an accessory)

CK65 Alphanumeric (51-Key) – N6803 FlexRange – 13MP Camera – 4GB RAM/ 32GB Flash

CK65-LON-B8C214x CK65, Alphanumeric, Android GMS, 2x2 MIMO 802.11 a/b/g/n/ac/r/k/mc, N6803 FlexRange, 4GB/32GB Memory, 13MP Camera, BT 5.0, NFC

CK65 Numeric F-Key (38-Key) – N6803 FlexRange – 13MP Camera – 4GB RAM/ 32GB Flash

CK65-LON-D8C214x CK65, Numeric F-Key, Android GMS, 2x2 MIMO 802.11 a/b/g/n/ac/r/k/mc, N6803 FlexRange, 4GB/32GB Memory, 13MP Camera, BT 5.0, NFC

CK65 Large Numeric (30-Key) – N6803 FlexRange – 13MP Camera – 4GB RAM/ 32GB Flash

CK65-LON-E8C214x CK65, Large Numeric, Android GMS, 2x2 MIMO 802.11 a/b/g/n/ac/r/k/mc, N6803 FlexRange, 4GB/32GB Memory, 13MP Camera, BT 5.0, NFC

(Note: x = Domain, select appropriate Domain from Configuration Map on page 9)

Honeywell Repair Services

SVCCK65-5FC3

CK65, PLUS, 5 Day Turnaround, 3 Year, Day One

CK65 Mobile Computer - Configuration Guide

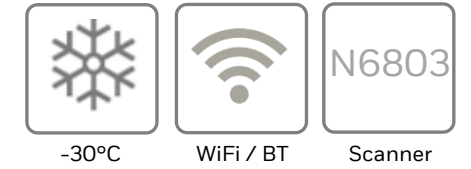

Alphanumeric (51-Key)

Numeric F-Key (38-Key)

Large Numeric (30-Key)

N6803 FlexRange™ (FR)

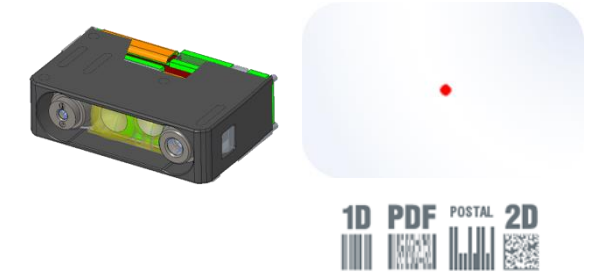

- Included in the box:
- CK65 Mobile Computer
 - Cold Storage Battery
 - Hand strap

(Stylus is not included, but available to order separately as an accessory)

CK65 Alphanumeric (51-Key) – Cold Storage – N6803 FlexRange – No Camera – 4GB RAM/ 32GB Flash

CK65-LON-B8N212x

CK65, Alphanumeric, Android GMS, 2x2 MIMO 802.11 a/b/g/n/ac/r/k/mc, N6803 FlexRange, Cold Storage, 4GB/32GB Memory, No Camera, BT 5.0, NFC

CK65 Numeric F-Key (38-Key) – Cold Storage – N6803 FlexRange – No Camera – 4GB RAM/ 32GB Flash

CK65-LON-D8N212x

CK65, Numeric F-Key, Android GMS, 2x2 MIMO 802.11 a/b/g/n/ac/r/k/mc, N6803 FlexRange, Cold Storage, 4GB/32GB Memory, No Camera, BT 5.0, NFC

CK65 Large Numeric (30-Key) – Cold Storage – N6803 FlexRange – No Camera – 4GB RAM/ 32GB Flash

CK65-LON-E8N212x

CK65, Large Numeric, Android GMS, 2x2 MIMO 802.11 a/b/g/n/ac/r/k/mc, N6803 FlexRange, Cold Storage, 4GB/32GB Memory, No Camera, BT 5.0, NFC

(Note: x = Domain, select appropriate Domain from Configuration Map on page 9)

Honeywell Repair Services

SVCCK65-5FC3

CK65, PLUS, 5 Day Turnaround, 3 Year, Day One

CK65 Mobile Computer - Configuration Guide

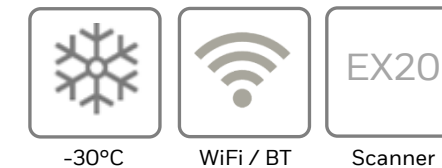

Alphanumeric (51-Key)

Numeric F-Key (38-Key)

Large Numeric (30-Key)



- Included in the box:
- CK65 Mobile Computer
 - Cold Storage Battery
 - Hand strap

(Stylus is not included, but available to order separately as an accessory)

CK65 Alphanumeric (51-Key) – Cold Storage – EX20 Near/ Far – No Camera – 4GB RAM/ 32GB Flash

CK65-LON-BMN212x CK65, Alphanumeric, Android GMS, 2x2 MIMO 802.11 a/b/g/n/ac/r/k/mc, 1D/2D Near/Far Imager (EX20), Cold Storage, 4GB/32GB Memory, No Camera, BT 5.0, NFC

CK65 Numeric F-Key (38-Key) – Cold Storage – EX20 Near/ Far – No Camera – 4GB RAM/ 32GB Flash

CK65-LON-DMN212x CK65, Numeric F-Key, Android GMS, 2x2 MIMO 802.11 a/b/g/n/ac/r/k/mc, 1D/2D Near/Far Imager (EX20), Cold Storage, 4GB/32GB Memory, No Camera, BT 5.0, NFC

CK65 Large Numeric (30-Key) – Cold Storage – EX20 Near/ Far – No Camera – 4GB RAM/ 32GB Flash

CK65-LON-EMN212x CK65, Large Numeric, Android GMS, 2x2 MIMO 802.11 a/b/g/n/ac/r/k/mc, 1D/2D Near/Far Imager (EX20), Cold Storage, 4GB/32GB Memory, No Camera, BT 5.0, NFC

(Note: x = Domain, select appropriate Domain from Configuration Map on page 9)

Honeywell Repair Services

SVCCK65-5FC3 CK65, PLUS, 5 Day Turnaround, 3 Year, Day One

CK65 Mobile Computer - Configuration Guide

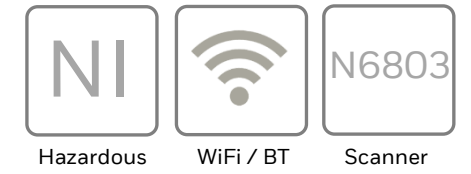

Alphanumeric (51-Key)

Numeric F-Key (38-Key)

Large Numeric (30-Key)

N6803 FlexRange™ (FR)

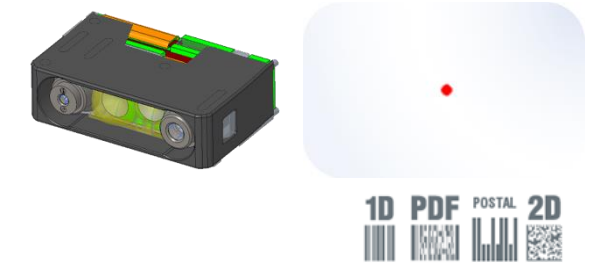

- Included in the box:
- CK65 Mobile Computer
 - NI/ ATEX / IECex Battery
 - Hand strap

(Stylus is not included, but available to order separately as an accessory)

CK65 Alphanumeric (51-Key) – N6803 FlexRange – 13MP Camera – 4GB RAM/ 32GB Flash

CK65-LON-B8C211x

CK65, Alphanumeric, Android GMS, 2x2 MIMO 802.11 a/b/g/n/ac/r/k/mc, N6803 FlexRange, Non-Incendive Certified, 4GB/32GB Memory, 13MP Camera, BT 5.0, NFC

CK65 Numeric F-Key (38-Key) – N6803 FlexRange – 13MP Camera – 4GB RAM/ 32GB Flash

CK65-LON-D8C211x

CK65, Numeric F-Key, Android GMS, 2x2 MIMO 802.11 a/b/g/n/ac/r/k/mc, N6803 FlexRange, Non-Incendive Certified, 4GB/32GB Memory, 13MP Camera, BT 5.0, NFC

CK65 Large Numeric (30-Key) – N6803 FlexRange – 13MP Camera – 4GB RAM/ 32GB Flash

CK65-LON-E8C211x

CK65, Large Numeric, Android GMS, 2x2 MIMO 802.11 a/b/g/n/ac/r/k/mc, N6803 FlexRange, Non-Incendive Certified, 4GB/32GB Memory, 13MP Camera, BT 5.0, NFC

(Note: x = Domain, select appropriate Domain from Configuration Map on page 9)

Honeywell Repair Services

SVCCCK65-5FC3

CK65, PLUS, 5 Day Turnaround, 3 Year, Day One

CK65 Mobile Computer - Configuration Guide

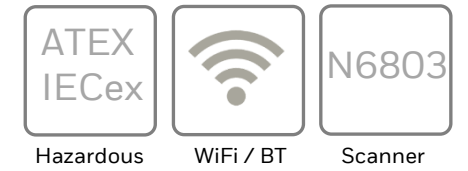

Alphanumeric (51-Key)

Numeric F-Key (38-Key)

Large Numeric (30-Key)

N6803 FlexRange™ (FR)

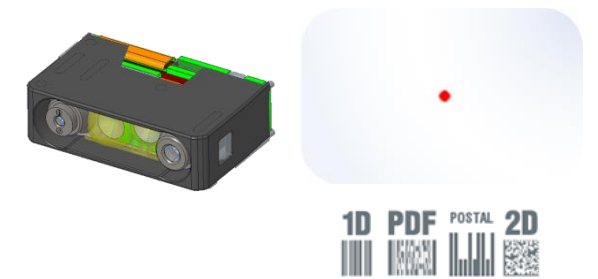

- Included in the box:
- CK65 Mobile Computer
 - NI/ ATEX / IECex Battery
 - Hand strap

(Stylus is not included, but available to order separately as an accessory)

CK65 Alphanumeric (51-Key) – N6803 FlexRange – 13MP Camera – 4GB RAM/ 32GB Flash

CK65-LON-B8C213x

CK65, Alphanumeric, Android GMS, 2x2 MIMO 802.11 a/b/g/n/ac/r/k/mc, N6803 FlexRange, ATEX/ IECex Certified, 4GB/32GB Memory, 13MP Camera, BT 5.0, NFC

CK65 Numeric F-Key (38-Key) – N6803 FlexRange – 13MP Camera – 4GB RAM/ 32GB Flash

CK65-LON-D8C213x

CK65, Numeric F-Key, Android GMS, 2x2 MIMO 802.11 a/b/g/n/ac/r/k/mc, N6803 FlexRange, ATEX/ IECex Certified, 4GB/32GB Memory, 13MP Camera, BT 5.0, NFC

CK65 Large Numeric (30-Key) – N6803 FlexRange – 13MP Camera – 4GB RAM/ 32GB Flash

CK65-LON-E8C213x

CK65, Large Numeric, Android GMS, 2x2 MIMO 802.11 a/b/g/n/ac/r/k/mc, N6803 FlexRange, ATEX/ IECex Certified, 4GB/32GB Memory, 13MP Camera, BT 5.0, NFC

(Note: x = Domain, select appropriate Domain from Configuration Map on page 9)

Honeywell Repair Services

SVCCCK65-5FC3

CK65, PLUS, 5 Day Turnaround, 3 Year, Day One

CK65 Mobile Computer - Configuration Guide

DIRECT
PART
MARKING
DPM

WiFi / BT

N6703
Scanner



- Included in the box:
- CK65 Mobile Computer
 - Battery
 - Hand strap

(Stylus is not included, but available to order separately as an accessory)



N6703 Standard Range (SR)



Sample DPM Barcodes

CK65 Alphanumeric – N6703 SR – 13MP Camera – 4GB RAM/ 32GB Flash

CK65-LON-BHC210x CK65, Alphanumeric, Android GMS, 2x2 MIMO 802.11 a/b/g/n/ac/r/k/mc, 1D/2D Imager SR (N6703) + DPM, 4GB/32GB Memory, 13MP Camera, BT 5.0, NFC

CK65 Numeric F-Key – N6703 SR – 13MP Camera – 4GB RAM/ 32GB Flash

CK65-LON-DHC210x CK65, Numeric F-Key, Android GMS, 2x2 MIMO 802.11 a/b/g/n/ac/r/k/mc, 1D/2D Imager SR (N6703) + DPM, 4GB/32GB Memory, 13MP Camera, BT 5.0, NFC

Direct Part Marking (DPM) License can be added to Standard CK65 with N6703 Scan Engine (non-DPM from factory) at any time by purchasing the DPM License.





454-055-001 License, Direct Part Marking. Single device license for enabling enhanced DPM functionality on handheld computers using the EA30, N5603, N6603, or N6703 scan engine.

(Note: x = Domain, select appropriate Domain from Configuration Map on page 9)

Honeywell Repair Services

SVCCCK65-5FC3 CK65, PLUS, 5 Day Turnaround, 3 Year, Day One

CK65 Configuration Map

Bluetooth/ WiFi	WWAN	NFC	Memory/ Keyboard	Imager	Camera	Operating System	Application	Custom	Domain	Description	Notes
CK65-											
L										802.11 a/b/g/n/ac/r/k/mc + Bluetooth 5.0	
	O									No WWAN	
		N								Near Field Communication (NFC)	Integrated Near Field Communication
			-								
			A							Alphanumeric - 2GB RAM/32GB Flash Memory	2GB RAM Not Available with Camera Option
			B							Alphanumeric - 4GB RAM/32GB Flash Memory	
			C							Numeric F-Key - 2GB RAM/32GB Flash Memory	2GB RAM Not Available with Camera Option
			D							Numeric F-Key - 4GB RAM/32GB Flash Memory	
			E							Large Numeric - 4GB RAM/32GB Flash Memory	
				8						1D/2D Imager (N6803) – FlexRange™	
				S						1D/2D Imager (N6703)	
				H						1D/2D Imager (N6703) + Direct Part Marking (DPM)	DPM license can also be added separately to standard CK65-xxx-xSxxxxx N6703 454-055-001 DPM License 
				M						EX20 Near/ Far 2D Area Imager	
					C					13MP Camera	13-megapixel color camera auto focus with flash (rear), 4K video with image stabilization, and advanced software features for enhanced exposure control
					N					No Camera	
						1				Android (Non-GMS)	
						2				Android (GMS)	Google Mobile Services (GMS) certified – Play Store
							1			Standard	Pre-licensed – SmartTE (1 Year Maintenance Included), Launcher, Enterprise Browser
							0			Standard Environment	
							1			Non-Incendive (NI)	
							2			Cold Storage	
							3			ATEX / IECex	
							4			Standard Environment	N6803FR Scan Engine Only
							A			ANZ & Argentina	Argentina, Australia, New Zealand
							E			World Wide	Austria, Belgium, Brazil, Bulgaria, China, Columbia, Croatia, Cyprus, Czech Republic, Denmark, Dominican Republic, Estonia, Finland, France, Germany, Greece, Hong Kong, Iceland, Ireland, Italy, Japan, Jordan, Kuwait, Latvia, Liechtenstein, Lithuania, Luxembourg, Malta, Morocco, Netherlands, Norway, Oman, Poland, Portugal, Qatar, Romania, Russia, Saudi Arabia, Singapore, Slovakia, Slovenia, South Africa, South Korea, Spain, Sri Lanka, Sweden, Switzerland, Thailand, UAE, Ukraine, United Kingdom, Vietnam
							F			FCC	USA, Canada, Guatemala, Mexico, Panama, Paraguay, Puerto Rico, Taiwan, Venezuela
							M			Miscellaneous 2.4GHz	Egypt, Honduras, India, Indonesia, Malaysia
							N			Miscellaneous 2.4GHz & 5GHz (U-NII 1, 2A & 3)	Egypt, Honduras, India, Indonesia, Malaysia



Honeywell Repair Services

CK65 – Repair Services

For Best-In-Class Service

With Honeywell Repair Services, it's easy to get the level of repair coverage and protection that makes the most sense for your business. And our repair services are now available in over 70 countries with global pricing and global standards of quality.

Choose from one of our new cost-effective Repair Service contract programs – Complete, Plus or Basic – to get the right amount of coverage and protection you need for your durable, rugged and ultra-rugged products. And for equipment not covered by a contract service plan, you can choose from our Non-Contract Repair Service offerings, which include flat-rate repairs, time-and-materials repairs and more.

Ensure business continuity, workflow performance and protection of your technology investments with Honeywell Repair Services.

Plus Repair Services

Protect your technology investment! With Honeywell's 3 and 5 year Plus comprehensive repair services plan, you won't incur any additional costs beyond the plan enrollment for service on covered devices and eligible accessories included with equipment sent to the depot for service. Eligible accessories include damaged styluses, battery-door covers, screen protectors, hand straps and clips.

Service Overview

- Features and benefits include:
 - Comprehensive coverage – including device replacement for rugged or stationary products
 - Day One multi-year pricing for lower annualized costs
 - Three years of locked-in service-price protection, with optional renewals
 - Options for 2-day and 5-day service levels
 - Cleaning and preventive maintenance
 - Telephone-based technical support
 - Convenient online Return Authorization requests and access to online service-history reports

Complete Repair Services

The only contract you will ever need! With Honeywell's 3 and 5 year Complete comprehensive repair services plan, one contract covers it all – device, power management and accessories. Eligible accessories and power management for mobile computers include: batteries, docks, chargers, cradles, cables, damaged styluses, battery-door covers, screen protectors, hand straps and clips.

Service Overview

- Features and benefits include:
 - Comprehensive coverage – including device replacement for rugged or stationary products
 - Coverage for power management and select accessories
 - Day One multi-year pricing for lower annualized costs
 - Five years of locked-in service-price protection
 - Options for overnight and 2-day or 5-day service levels
 - Cleaning and preventive maintenance
 - Telephone-based technical support
 - Convenient online Return Authorization requests and access to online service-history reports

Part#	Description
SVCCCK65-5FC3	CK65, PLUS, 5 Day Turnaround, 3 Year Day One
SVCCCK65-5FC5	CK65, PLUS, 5 Day Turnaround, 5 Year, Day One
SVCCCK65-2FC3	CK65, PLUS, 2 Day Turnaround, 3 Year, Day One
SVCCCK65-2FC5	CK65, PLUS, 2 Day Turnaround, 5 Year, Day One

Part#	Description
SVCCCK65-5PS3	CK65, COMPLETE, 5 Day Turnaround, 3 Year, Day One Includes Power Management Protection, Browser Maintenance, Battery Refresh (APAC Only)
SVCCCK65-2PS5	CK65, COMPLETE, 2 Day Turnaround, 5 Year, Day One Includes Power Management Protection, Browser Maintenance, Battery Refresh

Honeywell Repair Services

CK65 – Repair Services

For Best-In-Class Service



CK65

Warranty Cover Against Product Defect

BASIC Service

Comprehensive Coverage:

- Device Replacement
- Accidental Damage
- Wear & Tear

Includes Replacement of:

- Hand Strap
- Screen Protector



PLUS Service

Complete Coverage

- Battery Replacement
- Coverage for Docks/ Chargers
- Software Maintenance for Client Pack (Enterprise TE + Browser)
- Sentinel Extended Service for Android Security Updates



Pistol Grip



Vehicle Dock



Snap-On Adapters



Battery
(3 Year – 1 replacement battery per CK65)
(5 Year – 2 replacement batteries per CK65)



Docks



Dock Power Supplies

COMPLETE Service

Part#	Description
SVCC65-EXW2	CK65, BASIC, 10-15 Day Turnaround, 2 Years (1 Year Factory Warranty + 1 Year Extended)
SVCC65-5FC3	CK65, PLUS, 5 Day Turnaround, 3 Year, Day One
SVCC65-5PS3	CK65, COMPLETE, 5 Day Turnaround, 3 Year Day One, Includes Power Management Protection, Accessory Coverage and Software Maintenance for Client Pack.

Honeywell Repair Services

CK65 – Repair Services

For Best-In-Class Service

Advanced Exchange Service: Your Equipment "On Demand"

For overnight replacement of your Honeywell device, upgrade to our Advanced Exchange Service.

- Customer-owned, Honeywell-managed inventory ready for overnight shipment when you need it.
- Ship the damaged device to us; we'll repair it and add it to your Honeywell managed inventory to replace the device we shipped.

Part Number	Description
SVCK65-AEFC3	CK65, PLUS, Advanced Exchange, 3 Year, Day 1

Golden Image

Need the Honeywell Repair Centre to load your software after repair, the Golden Image can be loaded to fast track your devices.

- This is an additional offering which can be added to your Plus and Complete Service.
- Please contact your local Honeywell Representative for more information on this service.

Part Number	Description
SVCMOB-IMAGE3	Golden Image Service - load of customer image on units in repair, Adder to Comprehensive Service, 3 Year Term, 100 unit minimum, Contact Services Sales Manager for Pricing

SVCMOB-IMAGE5	Golden Image Service - load of customer image on units in repair, Adder to Comprehensive Service, 5 Year Term, 100 unit minimum, Contact Services Sales Manager for Pricing
---------------	---

Extending Android Security Patch Support

Honeywell's latest service innovation, Sentinel Service, reduces the exposure to threats to your Honeywell mobile devices by providing the following:

- Easy access to OS updates during support period
- Predictable security updates after end-of support date for Android™ 6.0 or greater
- Upgrades to the latest OS if available

Not only does Sentinel Service protect against threats but it can also reduce the total cost of ownership by extending the life of the OS up to 2 years beyond the Google® end-of-support date.

Sentinel Service comes standard with a Honeywell COMPLETE Service Contract or can be added on to any 3- or 5-year Honeywell PLUS Service Contract.

Part#	Description
SVCSSENTINEL-MOB1	Sentinel Service, 1 Year Android Support Contract
SVCSSENTINEL-MOB2	Sentinel Service, 2 Year Android Support Contract



CK65 Software

CK65 – Client Pack

All CK65 units will ship with Client Pack pre-licensed which includes first year maintenance. Add additional years of software maintenance for the applications below.



Launcher

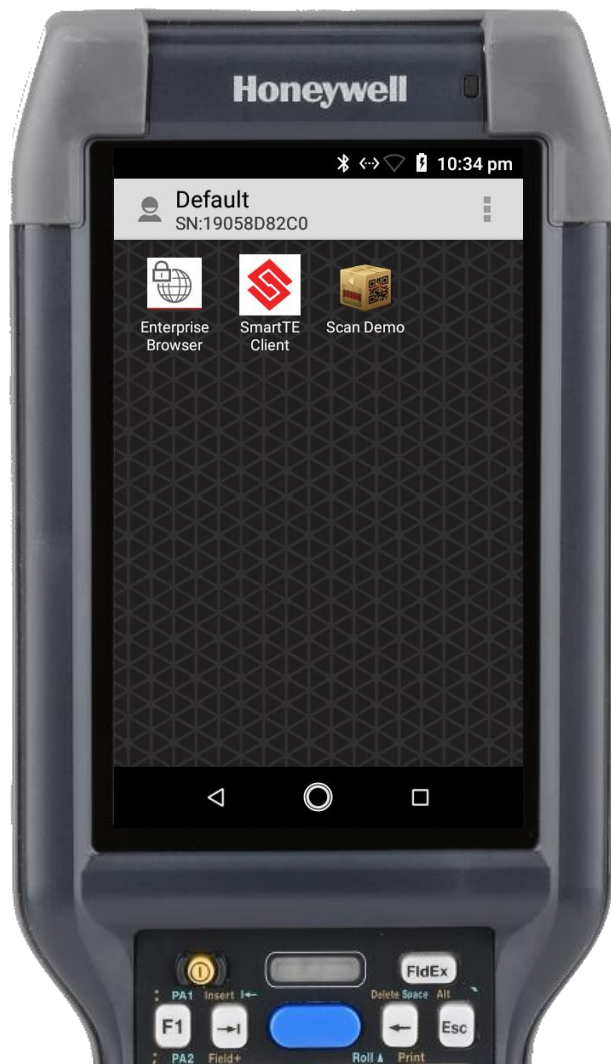

Launcher - gives the customer total control over which apps can be run on the device.

Part#	Description
SCP-SFT1	Software Client Pack - 1 Year Maintenance (Launcher & Enterprise Browser)
SCP-SFT3	Software Client Pack - 3 Year Maintenance (Launcher & Enterprise Browser)



Enterprise Browser



Enterprise Browser provides corporations the ability to run standard web applications from a controlled environment.



SmartTE Terminal Emulator



Terminal Emulator – Full featured SmartTE allows legacy green screen apps to be transformed to the look and feel of native apps.

Part#	Description
SMARTTE-SFT3	SmartTE – 3 Year SW Maintenance
SMARTTE-SFT5	SmartTE – 5 Year SW Maintenance

CK65 Accessories

Scan Handle

Use for Scan intensive applications



Part Number	Description
1 203-879-003	Pistol Grip kit, CK3/EDA60K/CK65 Field attachable scan handle (replaces the hand strap)

CK65 Accessories

Rubber Boot

For added protection of the CK65



Part Number	Description
1 213-064-001	CK65 Rubber Boot N6703/ N6803 Kit Compatible with Handstrap or Scan Handle Not compatible with Terminal Chargers, Holsters or Vehicle Dock

Part Number	Description
1 213-063-001	CK65 Rubber Boot EX20 Kit Compatible with Handstrap or Scan Handle Not compatible with Terminal Chargers, Holsters or Vehicle Dock

CK65 Desktop Communications

Option 1 – Portable

USB Communication to PC/ Mac OR Snap-On Charging



Part Number	Description
1 203-990-001	UNIVERSAL AC ADAPTER KIT, 10W, W/ CABLE (Universal Wall Charger kit (includes wall power supply, changeable plug type, and 236-297-001 power/ comms cable). Plugs directly to heel connector. Global Level VI Certified

Option 2 – Fixed

USB Communication & Single Battery Charger

- Supports Batteries:
- 318-033-011 - Battery, Standard CK3 (2000mAh)
 - 318-034-034 - Battery, Extended CK3 (5100mAh)
 - 318-063-001 - Smart Battery Pack,CK65 (7000mAh)
 - 318-063-002 - Smart Battery Pack, Cold Storage,CK65 (5200mAh)
 - 318-063-003 - Smart Battery Pack, NI/ ATEX,CK65 (7000mAh)



Part Number	Description
1 871-228-201	CK3/CK65 Single Dock, must order Power Supply & Power Cord separately
2 CBL-500-120-S00-03	USB type A to Micro USB, 1.2 m (3.9 ft)
3 851-061-502	AC adapter, 99ex Desktop Single Dock & Quad Battery Charger (Non-US Only)
4 **	AC Power Cord – See Page 29 for Country Specific Power Cords

CK65 Desktop Communications

Option 3 – Build your own FlexDock USB

USB Host and Client & Dual Battery Charger



Part Number	Description
1	852-920-002 FlexDock Base Desktop
2	203-916-001 FlexDock Cup, Mobile Computer, CK3/CK65
3	203-917-001 FlexDock Cup, Battery Pack, CK70/71/75/CK3
4	851-812-001 AC ADAPTER,12V/60W,2.5X5.5MM,LEVEL VI
5	** AC Power Cord – See Page 29 for Country Specific Power Cords

Honeywell Repair Services

SVCFLEXDOCK-5FC3 FlexDock, All Versions, Full Comprehensive, 5 Day Turnaround, 3 Year Day One

Option 4 – Build your own FlexDock Charge Only /Ethernet

Dual CK65 Charging
Charge Only or Ethernet



Part Number	Description
1	852-918-002 FlexDock Base Dual <u>C</u> harge Only
OR	852-919-002 FlexDock Base Dual <u>E</u> thernet
2	203-916-001 FlexDock Cup, Mobile Computer, CK3/ CK65 (Order 2 Cups per base)
3	851-812-001 AC ADAPTER,12V/60W,2.5X5.5MM,LEVEL VI
4	** AC Power Cord – See Page 29 for Country Specific Power Cords

Honeywell Repair Services

SVCFLEXDOCK-5FC3 FlexDock, All Versions, Full Comprehensive, 5 Day Turnaround, 3 Year Day One

CK65 Snap-On Accessory

AC Power Only

Snap-On Charging



	Part Number	Description
1	850-817-002	Adapter, Power Snap-On (AA23) w/Kapton
2	851-065-315	Universal Adapter, Right Angle, 12VDC 1.35x3.5mm,LVL V,AE23
3	**	AC Power Cord – See Page 29 for Country Specific Power Cords

CK65 Vehicle Install

Option 1 – Fixed Vehicle Install with direct connection to vehicle battery

Best used when the vehicle input voltage varies, 12- 24V.



Part Number	Description
1 871-231-102	Vehicle Dock, CK3/CK65 (AV10)
2 203-802-001	Vehicle Dock Installation Kit RoHS (Includes power cables and cable mounting hardware.)
3 805-611-001	Mounting Kit, V-Dock RoHS

CK65 Vehicle Install

Option 2 – Fixed Vehicle Install with Thor DC/DC Converter

Best used when the vehicle input voltage varies, 6-60V or 15-96V.

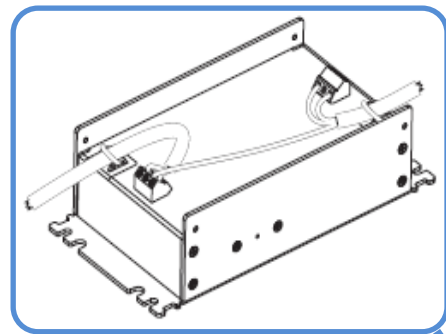

DC Converter Wiring



Part Number	Description
1 871-231-102	Vehicle Dock, CK3/CK65 (AV10)
2 9000311PWRSPPLY	DC/DC Converter Kit, <u>9-60V</u> DC, RoHS (Requires 226-109-003 Wiring Harness)
OR 9000313PWRSPPLY	DC/DC Converter Kit, <u>50-150V</u> DC RoHS (Requires 226-109-003 Wiring Harness)
226-109-003	72" (182.88 cm) Fuse block Power Cable with spade lugs and 3-pin connector
3 805-611-001	Mounting Kit, V-Dock RoHS

CK65 Vehicle Install

CK65 Vehicle Dock 360 degree view



Front View



Rear View



Side View
Scan Handle is compatible with Vehicle Dock

CK65 Vehicle Install

CK65 Vehicle Dock DB15M USB I/O Connector



Note: Vehicle Dock must have external power connected for USB port to be active.



VE011-2016 Single USB type A breakout cable (Provides USB Host Connection)



VE011-2018 Developer Cable (Provides USB Client Connection)



340-054-102 Keyboard,Rugged,QWERTY,5250,Xtreme Temp (DB15/USB port)

CK65 Vehicle Install

CK65 Vehicle Dock DB15M USB I/O Connector – USB Scanner

CK65 / CK71 / CK75 / CN80 / CV31 Custom USB

CBL-015-250-C00	CABLE, USB, DB15 FEMALE 5V, INDUSTRIAL	2.5m	COILED	Connect direct to the CK65 Vehicle Dock DB15 USB Port
-----------------	--	------	--------	---

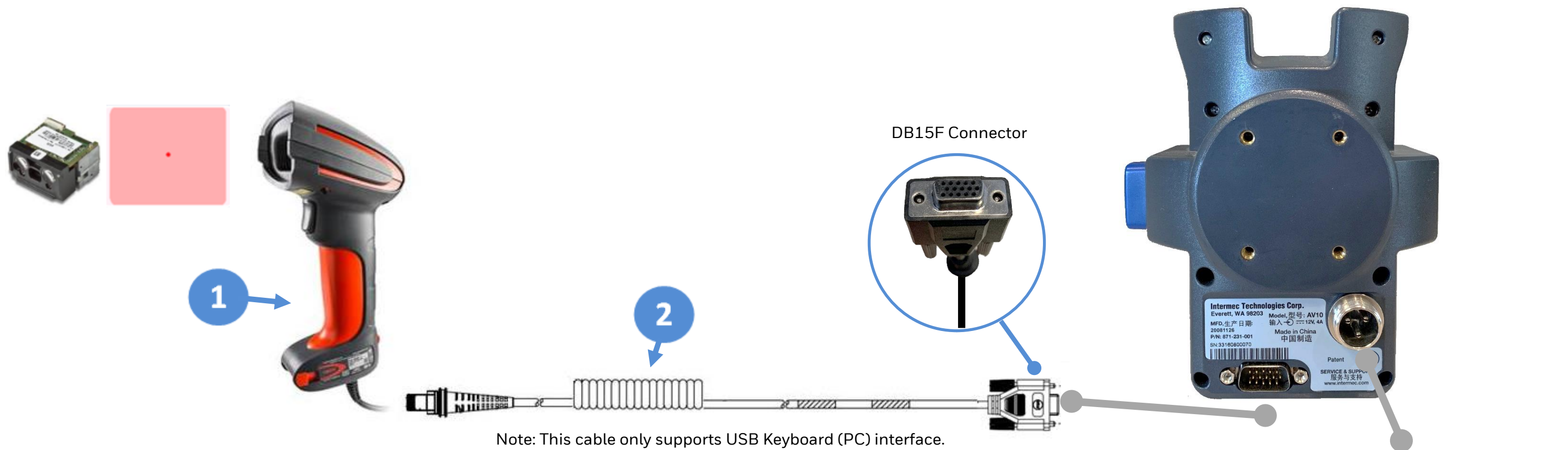
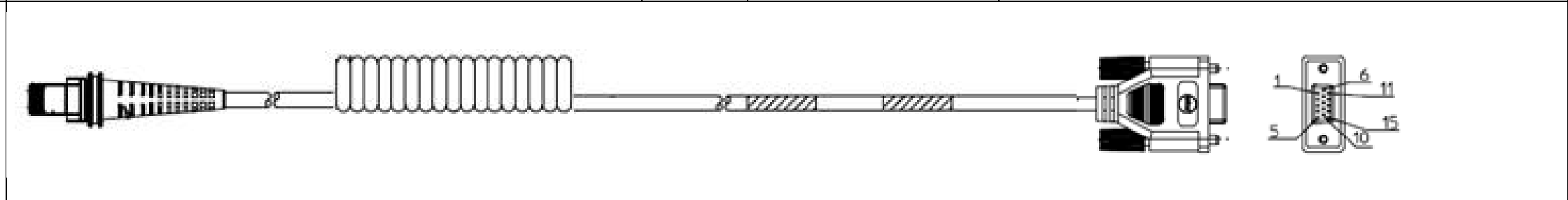

Note: Vehicle Dock must have external power connected for DB15 USB port to be active.

Part Number	Description
1	1980iFR-3 Scanner, 1D/2D, FR focus, red, RS232/USB, with vibrator
2	CBL-015-250-C00 CABLE, USB, DB15 FEMALE 5V, INDUSTRIAL

CK65 Charging and Communications

Option 1 – CK3 Quad Legacy Charger

Supports: CK3A/CK3B/CK3R/CK3X and CK65 with any battery installed in the computer.

Optional, this dock also supports:
203-641-002 FlexDock/Multidock Wall Mounting Kit



Part Number	Description
1	871-229-202 Multidock, Ethernet CK3 (AD21)
OR	871-229-201 Multidock, Charge Only CK3 (AD22)
2	851-064-416 Universal Power Supply,12V, 8A,Level VI, AE21
3	** AC Power Cord – See Page 29 for Country Specific Power Cords

Option 2 – FlexDock 4-Bay Charger

Supports: CK3A/CK3B/CK3R/CK3X and CK65 with any battery installed in the computer.

Optional, this dock also supports:
203-641-002 FlexDock/Multidock Wall Mounting Kit



Part Number	Description
1	DX4A1444400 Quad Dock Ethernet CK3 No Power Cord (Power Supply Included)
OR	DX4A2444400 Quad Dock Charge Only CK3 No Power Cord (Power Supply Included)
2	** AC Power Cord – See Page 29 for Country Specific Power Cords

Honeywell Repair Services

SVCFLEXDOCK-5FC3 FlexDock, All Versions, Full Comprehensive, 5 Day Turnaround, 3 Year Day One

CK65 Battery Charging

Option 1 – CK3 Quad Legacy Charger

Supports Batteries: 318-033-011 - Battery, Standard CK3 (2000mAh)
 318-034-033 - Battery, Extended CK3 (5100mAh)
 318-034-034 - Battery, Extended CK3 (5100mAh)
 318-063-001 - Smart Battery Pack,CK65 (7000mAh)
 318-063-002 - Smart Battery Pack, Cold Storage,CK65 (5200mAh)
 318-063-003 - Smart Battery Pack, NI/ ATEX/ IECex,CK65



Part Number	Description
1 871-230-101	Quad Charger, CK3 (AC20)
2 851-061-502	AC adapter, 99ex Desktop Single Dock & Quad Battery Charger.
3 **	AC Power Cord – See Page 29 for Country Specific Power Cords

Option 2 – FlexDock 4-Bay Charger

Supports Batteries: 318-033-011 - Battery, Standard CK3 (2000mAh)
 318-034-033 - Battery, Extended CK3 (5100mAh)
 318-034-034 - Battery, Extended CK3 (5100mAh)
 318-046-031 - Smart Battery Pack, CK3R/CK3X/CK7x (5200mAh)
 318-046-032 - Smart Battery Pack,CK75 Cold Storage (5200mAh)
 318-063-001 - Smart Battery Pack,CK65 (7000mAh)
 318-063-002 - Smart Battery Pack, Cold Storage,CK65 (5200mAh)
 318-063-003 - Smart Battery Pack, NI/ ATEX/ IECex,CK65 (7000mAh)



Part Number	Description
1 DX2A2BB20	4-position Battery Charger, CK70/71, No Power Cord (Power Supply Included)
2 **	AC Power Cord – See Page 29 for Country Specific Power Cords

Honeywell Repair Services

SVCFLEXDOCK-5FC3 FlexDock, All Versions, Full Comprehensive, 5 Day Turnaround, 3 Year Day One

CK65 Battery Charging

Option 3 – FlexDock 8-Bay Charger

- Supports Batteries:
- 318-033-011 - Battery, Standard CK3 (2000mAh)
 - 318-034-033 - Battery, Extended CK3 (5100mAh)
 - 318-034-034 - Battery, Extended CK3 (5100mAh)
 - 318-046-031 - Smart Battery Pack, CK3R/CK3X/CK7x (5200mAh)
 - 318-046-032 - Smart Battery Pack,CK75 Cold Storage (5200mAh)
 - 318-063-001 - Smart Battery Pack,CK65 (7000mAh)
 - 318-063-002 - Smart Battery Pack, Cold Storage,CK65 (5200mAh)
 - 318-063-003 - Smart Battery Pack, NI/ ATEX/ IECex,CK65 (7000mAh)



	Part Number	Description
	1	DX4A2BBBB00 8-position Battery Charger, CK3/CK7x, No Power Cord (Power Supply Included)
	2	** AC Power Cord – See Page 29 for Country Specific Power Cords
Optional	3	203-641-002 FlexDock/Multidock Wall Mounting Kit

Honeywell Repair Services

SVCFLEXDOCK-5FC3 FlexDock, All Versions, Full Comprehensive, 5 Day Turnaround, 3 Year Day One

CK65 Battery

Spare Battery Options



Part Number	Description
1	318-063-001 Smart Battery Pack, CK65 (7000mAh)
OR	318-034-034 Battery, Extended CK3 (5100mAh)
2	318-063-002 Smart Battery Pack, Cold Storage, CK65 (5200mAh)
3	318-063-003 Smart Battery Pack, NI/ ATEX / IECex, CK65 (7000mAh)

Miscellaneous

CK65 Accessories

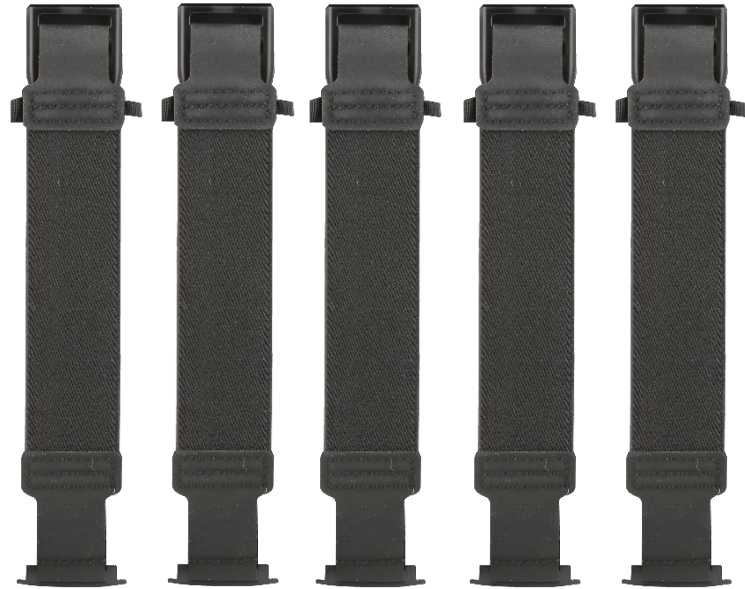

Part Number	Description
8754-870650-01	Handstrap Pack of 5



Part Number	Description
213-065-001	CK65, Pack of 5 screen protectors



Part Number	Description
815-088-001	Holster, CK3R/CK3X/CK65 with Scan Handle (Holster w/ Belt, supports CK3R/CK3X/CK65 with scan handle)



Stylus attaches to CK65 Hand strap. Not compatible with CK65 Pistol Grip

Part Number	Description
CN80-STY-5SH	Pack of 5 CN80 replacement styluses. (CK65 uses same stylus as CN80)



Part Number	Description
871-236-001	Vehicle Holder, CK65/CK3 No Electrical Connections



Part Number	Description
815-087-001	Holster, CK3R/CK3X/CK65 without Scan Handle

Miscellaneous

Honeywell Recommended – ATP Industrial Grade Micro SD Cards

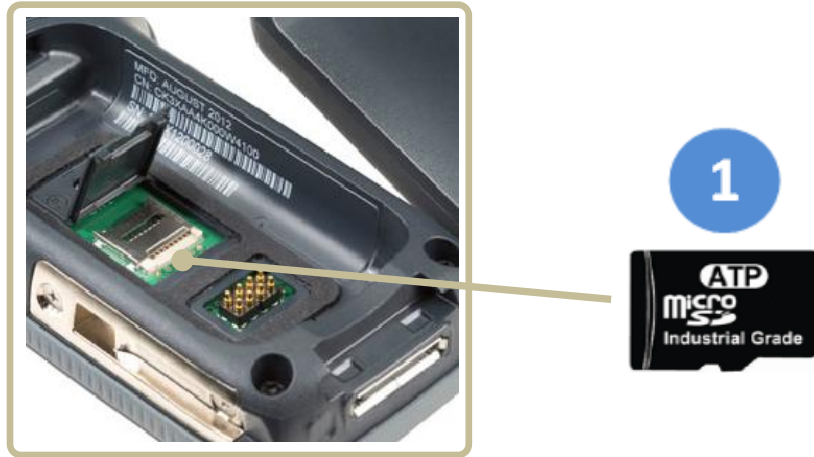

Part Number	Description
1 856-065-004	MICRO-SD CARD, <u>1GB</u> , AF1GUDI, ROHS
OR 856-065-005	MICRO-SD CARD, <u>2GB</u> , AF2GUDI, ROHS
OR 856-065-006	MICRO-SD CARD, <u>4GB</u> , AF4GUDI, ROHS
OR 856-065-007	MICRO-SD CARD, <u>8GB</u> , AF8GUDI, RoHS

Why ATP Industrial Grade SD?

ATP's SIP (System-In-Packaging) manufacturing process encapsulates all exposed components and points of failure to ensure the products are fully waterproof, shockproof, and ESD (Electro-Static Discharge) proof. ATP Industrial Grade SD/SDHC Cards can withstand at least an operating/storage temperature range of at least -40 to 85 degrees Celsius. In addition to this temperature range, the cards are completely waterproof, dustproof, and ESD (Electro-Static Discharge) proof. All ATP Industrial Grade SD/SDHC cards are produced under a stringent RoHS and Green Package compliant manufacturing process to guarantee a consistent high level of build quality and performance. ATP Industrial SD cards deliver outstanding performance with read speed (seq) up to 18MB/sec and write speed (seq) up to 16MB/sec. All ATP Industrial Grade CF, SD, USB drives, and SSDs are constructed using best-in-class SLC(Single-Level Cell) components with enhanced Error Correction Code(ECC) functions and wear levelling algorithms. This results in MTBF ratings over 2 million hours and the highest write cycle lifetimes in the industry.

AC Cords

Part Number	Description
50117501-001	AC Power Cord, Australia
19-19807	AC Power Cord, China
9000091CABLE	AC Power Cord, Denmark
77900508E	AC Power Cord, Europe
50127245-001	AC Power Cord, India
9000092CABLE	AC Power Cord, Italy
321-500-002	AC Power Cord, Japan
9000093CABLE	AC Power Cord, Switzerland
77900507E	AC Power Cord, United Kingdom
19-19726	AC Power Cord, United States

Disclaimer

Honeywell International Inc. (“HII”) reserves the right to make changes in specification and other information contained in this document without prior notice, and the reader should in all cases consult HII to determine whether any such changes have been made. The information in this publication does not represent a commitment on the part of HII.

HII shall not be liable for technical or editorial errors or omissions contained herein; nor for incidental or consequential damages resulting the furnishing, performance, or use of this material.

This document contains proprietary information that is protected by copyright. All rights are reserved. No part of this document may be photocopied, reproduced, or translated into another language with-out prior written consent of HII.

Web Address: www.honeywellaidc.com

The Bluetooth trademarks are owned by Bluetooth SIG, Inc., U.S.A and licensed to Honeywell.

Thor, Mobility Edge and FlexRange are trademarks or registered trademarks of Honeywell International Inc. in the United States and/or other countries.

Android is a trademark or registered trademark of Google Inc. in the United States and/or other countries.

Qualcomm and Snapdragon are trademarks or registered trademarks of Qualcomm Incorporated in the United States and/or other countries.

Other product names mentioned in the manual may be trademarks of registered trademarks of their respective companies and are the property of their respective owners.

All rights reserved.