

User Guide

NCR XL10W (5910)

Release 1.0 and 1.1



BCC5-0000-5197
Issue F



The product described in this document is a licensed product of NCR Corporation.

NCR is a registered trademark of NCR Corporation. NCR RealPOS is a trademark of NCR Corporation in the United States and/or other countries. Other product names mentioned in this publication may be trademarks or registered trademarks of their respective companies and are hereby acknowledged.

The terms HDMI and HDMI High-Definition Multimedia Interface, and the HDMI Logo are trademarks or registered trademarks of HDMI Licensing LLC in the United States and other countries.

Where creation of derivative works, modifications or copies of this NCR copyrighted documentation is permitted under the terms and conditions of an agreement you have with NCR, NCR's copyright notice must be included.

It is the policy of NCR Corporation (NCR) to improve products as new technology, components, software, and firmware become available. NCR, therefore, reserves the right to change specifications without prior notice.

All features, functions, and operations described herein may not be marketed by NCR in all parts of the world. In some instances, photographs are of equipment prototypes. Therefore, before using this document, consult with your NCR representative or NCR office for information that is applicable and current.

To maintain the quality of our publications, we need your comments on the accuracy, clarity, organization, and value of this book. Please use the link below to send your comments.

Email: FD230036@ncr.com

Copyright © 2017–2019
By NCR Corporation
Global Headquarters
864 Spring St NW
Atlanta, GA 30308
U.S.A.
All Rights Reserved

Preface

Audience

This book is written for hardware installer/service personnel, system integrators, and field engineers.

Notice: This document is NCR proprietary information and is not to be disclosed or reproduced without consent.

Safety Requirements

The *NCR XL10W (5910)* conforms to all applicable legal requirements. To view the compliance statements see the *NCR RealPOS Peripherals Safety and Regulatory Statements (B005-0000-1701)*.

IT Power System

This product is suitable for connection to an IT power system with a phase-to-phase voltage not exceeding 240 V.

Peripheral Usage

This terminal should only be used with peripheral devices that are certified by the appropriate safety agency for the country of installation (UL, CSA, TUV, VDE) or those which are recommended by NCR Corporation.



Warning: DO NOT connect or disconnect any serial peripherals while the terminal is connected to AC power. This can result in system damage.

Grounding Instructions

In the event of a malfunction or breakdown, grounding provides a path of least resistance for electric current to reduce the risk of electric shock. This product is equipped with an electric cord having an equipment-grounding conductor and a grounding plug. The plug must be plugged into a matching outlet that is properly installed and grounded in accordance with all local codes and ordinances. Do not modify the plug provided – if it will not fit the outlet, have the proper outlet installed by a qualified electrician. Improper connection of the equipment-grounding conductor can result in a risk of electric shock.

The conductor with insulation having an outer surface that is green with or without yellow stripes is the equipment-grounding conductor.

If repair or replacement of the electric cord or plug is necessary, do not connect the equipment-grounding conductor to a live terminal. Check with a qualified electrician or service personnel if the grounding instructions are not completely understood, or if you are in doubt as to whether the product is properly grounded.

Use only 3-wire extension cords that have 3-prong grounding plugs and 3-pole receptacles that accept the product's plug. **Repair or replace damaged or worn cords immediately.**

Out of Box Failure (OBF)

If you experience an out of box failure (OBF) during installation or staging related to a missing, wrong or defective unit or item, simply provide NCR with a detailed description of the issue and the item will be replaced free of charge. For assistance with this process send an email to CustomerSat.Retail@ncr.com with the following details:

- NCR Sales Order # (Sales Order # are located on the box)
- Date of Product Installation
- Product Model #
- Unit Serial #
- NCR part # of defective/missing/wrong component
- Description of Failure (please be specific. For example: "display will not power on")
- Customer/Requestor's contact name, phone number and/or e-mail address
- Address to ship replacement part(s)

Transport the product in its original packaging to prevent impact damages.

If you do not have access to a computer, you may leave a voice message at: 1-800-528-8658 (USA), or (International) +1-770-623-7400. When leaving a message, please provide a phone number and/or an email address so NCR can contact you if additional details are needed.



Note: Used equipment that experiences a failure does not qualify as an OBF and should go through the NCR warranty process.

Warranty

Warranty terms vary by region and country.

All parts of this product that are subject to normal wear and tear are not included in the warranty. In general, damages due to the following are not covered by the warranty.

- Improper or insufficient maintenance
- Improper use or unauthorized modifications of the product.
- Inadequate location or surroundings. Site installation must conform to guidelines listed in the *Site Preparation* section of this document and the *NCR Workstation and Peripheral AC Wiring Guide* (BST0-2115-53).

For detailed warranty arrangements please consult your contract documents.

Returning Defective Hardware for Service

Use the following procedure to report/return defective hardware.

Call the *NCR Customer Care Center* at 1-800-262-7782 and have the following information available when you place the call.

- Class/Model number of the defective equipment
- Serial Number of the defective equipment
- Equipment location in the store
- Description of the problem, including any system error codes, error condition, or guidance to the area of failure.

The NCR Agent will provide you with a work order number, which serves as your Return Material Authorization (RMA). Please provide the RMA on the outside of the shipping box.



Note: A work order must be opened for each device that is shipped for repair.

Table of Contents

Chapter 1: Product Overview

Base Models	2
Features and Benefits	3
Display Port Model Optional Features	4
USB Model Optional Features	7
Specifications	8
Display Mounts	10
XL10W Wedge Stand (5910-F030/K030)	10
XL-Series Stand (5910-F033, 5910-F233)	10
Integration Tray Mount (5968-K024)	11
X-Series Table Top Stand (5968-K031)	11
Checkstand Mount (5968-K039)	12
Wall Mount (7702-K320)	12
Third Party Mount	13
Quick Release Bracket (5915-K320)	13
Magnetic Stripe Reader (5910-F141, 5910-F241)	14
Data Encryption	14
Card Data Encoding	14
Card Thickness	14
Cube Scanner (5910-F173)	15
Miscellaneous Kits	16
5910-F302/K302	16
5915-K470	16
7613-K470	16
7702-K470	17
Label Locations	18
Display Port Model	18

USB Model	19
-----------------	----

Chapter 2: Hardware Installation

Installation Restrictions	20
Ergonomic Workplace	21
Installing the Display	22
Installing the Display to the XL-Series Stand	23
Installing the Display to the XL10W Wedge Stand	30
Installing the Display to the XL10W Pole Mount	33
Connecting to a POS Terminal	37
Display Port Model	37
USB Model	43

Chapter 3: Operation and Cleaning

Projected Capacitive Touchscreen	44
Using the PCAP Touchscreen	44
Touchscreen Cleaning Procedures	44
Magnetic Stripe Reader	45
Using the MSR	45
Care of Cards	45
Card Thickness	45
Cabinet Cleaning Procedures	46

Chapter 4: NCR Software OSD Utility

Introduction	47
Supported Features	47
Installing the Utility	48
Running the Utility (GUI Version)	49
Main Menu	49
Monitors Detected Panel	49
Center Panel	49
Control Buttons	50
Display Adjustment Procedures	52

Resetting Factory Defaults	53
Running the Utility (Console Version)	54

Revision Record

Issue	Date	Remarks
A	Nov 2017	First Issue
B	July 2018	Changed 1432-C681-0013 / 497-0517916 to 1432-C805-0013 / 497-0521105 Added XL10W Wedge Stand (F030)
C	Oct 2018	Added Anti-Glare and white features Added XL10W Pole Mount (F302) Added "Installing the Display to the XL10W Pole Mount" section Renamed "blank plate" to "filler plate" and "VESA Adapter" to "VESA Filler Plate"
D	Dec 2018	Renamed "VESA Filler Plate" to "Quick Release Bracket"
E	Nov 2019	Added Cube Scanner (F173)
F	Dec 2019	Updated terminology for USB with type C connector

Chapter 1: Product Overview



GCP-72320

The NCR XL10W (5910) display offers flexibility and ultra-thin design that will look great in any retail environment. The XL10W display features bright, high contrast LCD to make it easy to read. This stylish display is available as a 10-inch projected capacitive (PCAP) touchscreen or LED backlight non-touch.

The XL10W Display Port model is compatible with any product that has a display port video and a USB interface, and the XL10W USB model is compatible with any NCR terminal equipped with type C compatible USB port. The XL10W display can be used as an associate display or rear mounted to a terminal or free standing to display pricing and promotional messages. This is available with an encrypted magnetic stripe reader (MSR) for enhanced security. Whichever option is preferred, these displays are sure to enhance the appearance of the wrap stand or checkout and save valuable counter space.

Base Models

Base Model	Description
Display Port Model	
5910-1010-9090	XL10W, 10.1" Display, No Touch
5910-1310-9090	XL10W, 10.1" Display, PCAP
5910-2310-9090	XL10W, 10.1" Display, PCAP, White
5910-3010-9090	XL10W, 10.1" Display, No Touch with Anti-Glare
USB Model	
5910-5010-9090	XL10W, 10.1" Display, No Touch, USB
5910-5310-9090	XL10W, 10.1" Display, PCAP, USB

Features and Benefits

Features	Description	
Touch Displays	10.1" Projected Capacitive (PCAP)	<ul style="list-style-type: none"> • Zero Bezel • 10-Point Multi-Touch Interface • 400 NIT LED LCD • 16:10 Aspect Ratio • 1920x1200 Resolution • Display Port or USB DP Alt Mode • Software OSD Support
Non-Touch Displays	10.1" LED Backlight	<ul style="list-style-type: none"> • Zero Bezel • 400 NIT LED LCD • 16:10 Aspect Ratio • 1920x1200 Resolution • Display Port or USB DP Alt Mode • Software OSD Support
Peripherals	MSR, NCR Encrypted USB 3-Track	Provides a 3-Track, Encrypting MSR
	Filler Plate, Right Side	Provides a filler plate when an MSR is not installed
	Cube Scanner	Provides a Scanner
	Filler Plate, Left Side	Provides a blank plate when a Scanner is not installed

Display Port Model Optional Features

Optional Features			Description
Power Cord	5910-F100 1416-C325-0030	US Power Cord	Provides a 3 m (118.11 in.) power cord for an external power supply.
	5910-F101 1416-C323-0030	International Power Cord	
	5910-F102 1416-C321-0030	UK Power Cord	
	5910-F103 1416-C322-0030	Australia Power Cord	
	5910-F104 1416-C391-0030	China Power Cord	
	5910-F105 1416-C320-0030	SEV Power Cord	
	5910-F106 1432-C366-0030	India Power Cord	
	5910-F107 1416-C009-0018	Argentina Power Cord	
	1424-C124-0030	Japan Power Cord	
	Display Port Cables	1432-C614-0005	
5910-F110 1432-C614-0008		0.84 m (33.07 in.) Display Port Cable	Provides a display port cable used for integration with XR7 terminal using the rear display arm of the POS table top stand.
5910-F111 1432-C614-0013		1.3 m (51.18 in.) Display Port Cable	Provides a display port cable.
5910-F112 1432-C614-0040		4 m (157.48 in.) Display Port Cable	Provides a display port cable.

Optional Features		Description	
External Power Cables	5910-F120 5915-K100	Universal Switching MEPS Power Supply - 12V, 2.5 A output (ROHS)	Provides a 12VDC Power Adapter, 40W, DOE VI, 4 pin Mini-DIN connector.
	5910-F121 1432-C591-0013	1.3 m (51.18 in.) USB Type A with power connector	Provides a USB cable with latching 1x8 connector on the display end, a USB connector on the terminal end, and a barrel connector in the middle for an external power supply. Requires both an external power brick and a local power cord.
	5910-F122 1432-C591-0040	4 m (157.48 in.) USB Type A with power connector	Provides a USB cable with latching 1x8 connector on the display end, a USB connector on the terminal end, and a barrel connector in the middle for an external power supply. Requires both an external power brick and a local power cord.

Optional Features		Description	
Powered USB Cables	1432-C477-0005	0.5 m (19.69 in.) 12V Powered USB	Provides a 12V USB power cable with latching 1x8 connector on the display end and a latching 12V USB + Power connector on the terminal end. Provides both power and touch communication. To be used only on displays attached to the XR POS table top stand.
	5910-F117 1432-C477-0008	0.84 m (33.07 in.) 12V Powered USB	Provides a 12V USB power cable with latching 1x8 connector on the display end and a latching 12V USB + Power connector on the terminal end. Provides both power and touch communication.
	5910-F118 1432-C477-0013	1.3 m (51.18 in.) 12V Powered USB	Provides a 12V USB power cable with latching 1x8 connector on the display end and a latching 12V USB + Power connector on the terminal end. Provides both power and touch communication.
	5910-F119 1432-C478-0040	4 m (157.48 in.) 12V Powered USB	Provides a 12V USB power cable with latching 1x8 connector on the display end and a latching 12V USB + Power connector on the terminal end. Provides both power and touch communication.

Optional Features			Description
Audio Cable	5910-F126 1432-C593-0013	1.3 m (51.18 in.) with 3.5 mm plug Male	Provides a black cable for use on terminals with a line-out or audio port.
	5910-F127 1432-C593-0040	4 m (157.48 in.) with 3.5 mm plug Male	Provides a black cable for use on terminals with a line-out or audio port.
Miscellaneous Adapters	1432-C790-0001	Cable, HDMI (Terminal) to Display Port (Display) active adapter	Allows connection of a display with DisplayPort to a terminal with an HDMI connection. Must also order the DisplayPort cable. Powered by a USB port on terminal.
	1432-C791-0000	Adapter, passive, DVI-D to HDMI	Allows connection of a display with DisplayPort to a terminal with a DVI connection. Must also order the DisplayPort cable and the 1432-C790-0001 adapter.

USB Model Optional Features

Optional Features			Description
USB* Cable	5910-F132 1432-C805-0013	1.3 m (51.18 in.) USB* to USB*	1.3 m cable for XL10W paired with a PX10



Note: The * indicates USB cable connectors compatible with type C connectors.

Specifications

Feature	Specifications
Bezel	Zero bezel
Touch Technology	Projected Capacitive (PCAP) and Non-Touch
Touchscreen Operation	Human touch input
Touchscreen Life Expectancy	No known wear out point
Touch Driver	Microsoft
Touch Interface	USB
Periodic Touchscreen Calibration	No
Surface hardness	No known wear out point
Video Interface	Display Port or USB (compatible with type C ports)
Backlight	LED
External USB Connectivity	0
Net Luminance (cd/m2)	400 (typ)
Contrast Ratio	800:1
Native Resolution	1920x1200 (16:10) / 16.7 colors
Additional Resolutions Supported	Dependent on graphics driver capability
User Adjustable OSD Controls	Allows for adjustments through software OSD.
Viewing Direction	12 o'clock
Viewing Angle	170H/170W
Audio	Integrated speaker (non-amplified)
Power	1x8 latching 12V USB from POS
Power consumption	PCAP: 5.42w (typ), 3.25w (standby) NT: 4.94w (typ), 2.73w (standby)
MSR Option	NCR Encrypted 3-Track
Biometrics	None
Physical Mounting Interface	NCR custom & VESA 75 mm
Color	<ul style="list-style-type: none"> • Black • White

Feature	Specifications
Life (hours to ½ brightness of backlight)	30,000 hours
Retail Hardened	Yes – integrated enclosure, mounting, sealed front glass, software OSD, latching cables
Sealed against dust	Yes (front)
Sealed against liquid	Yes (front)
Certifications	TUV/UL/NOM/GOST/CCC
Display Area	216.81mm(H) x 135.5mm(V)
Operating Temperature	5° to 40°C
Operating Humidity	10% to 90% (non-condensing)
Dimensions (no stand/no MSR) (w x d x h)	261 mm (10.3”) x 32 mm (1.25”) x 179 mm (7.1”)
Weight (no stand/no MSR)	0.73 kg (1.6 lbs)
Miscellaneous weights	MSR: 0.06 kg (0.15 lbs)

Display Mounts

XL10W Wedge Stand (5910-F030/K030)

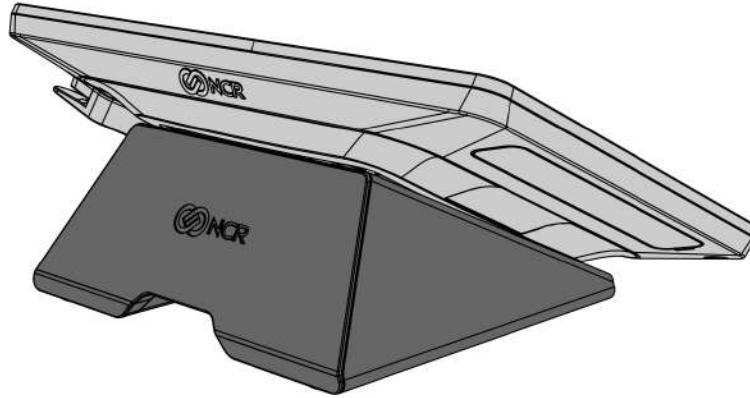

CCP-72989

XL-Series Stand (5910-F033, 5910-F233)



CCP-72304

Integration Tray Mount (5968-K024)

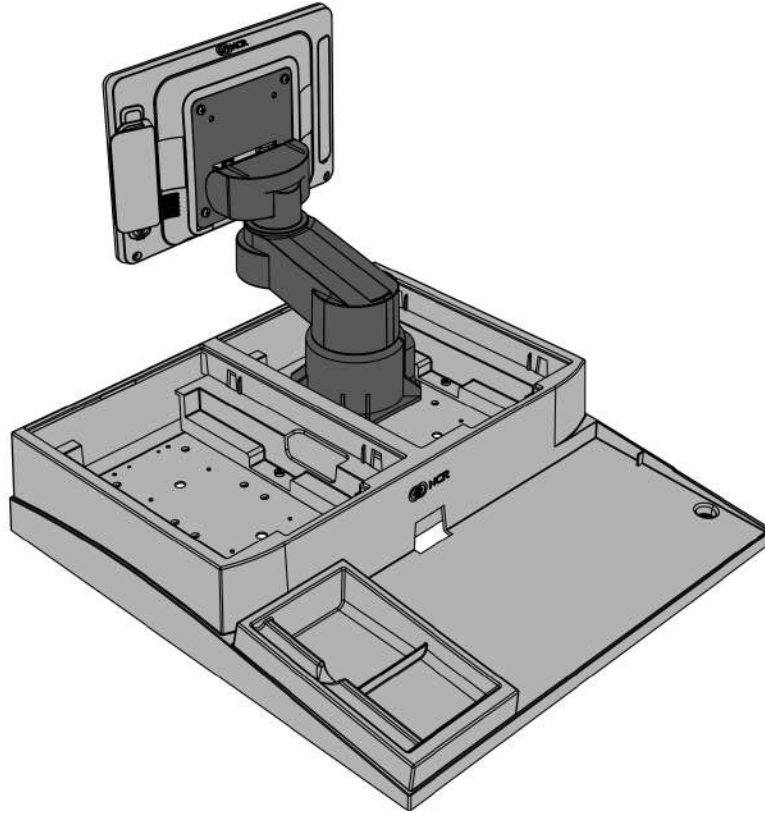

CCP-72305

X-Series Table Top Stand (5968-K031)

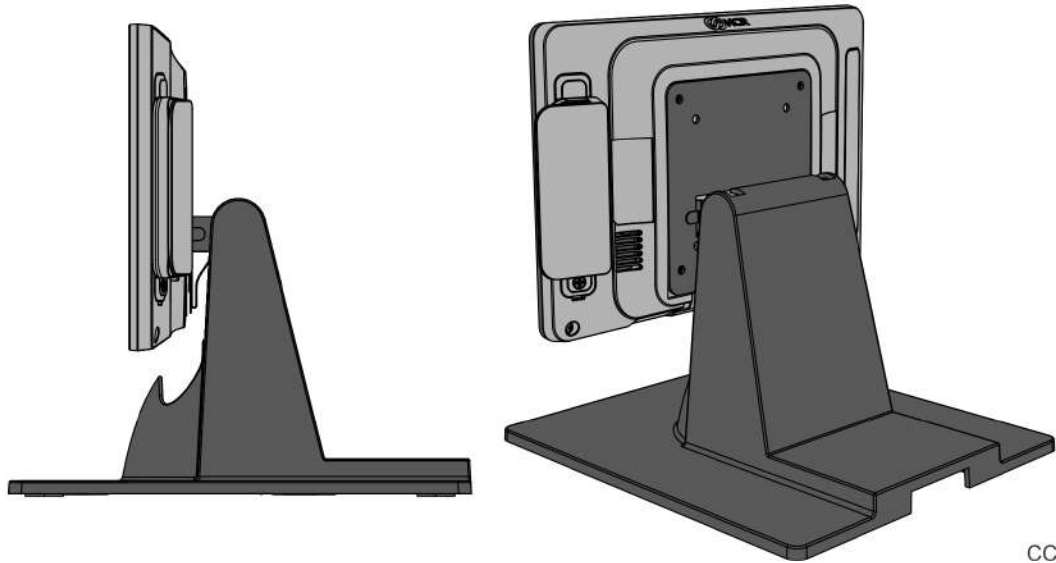

CCP-72306

Checkstand Mount (5968-K039)

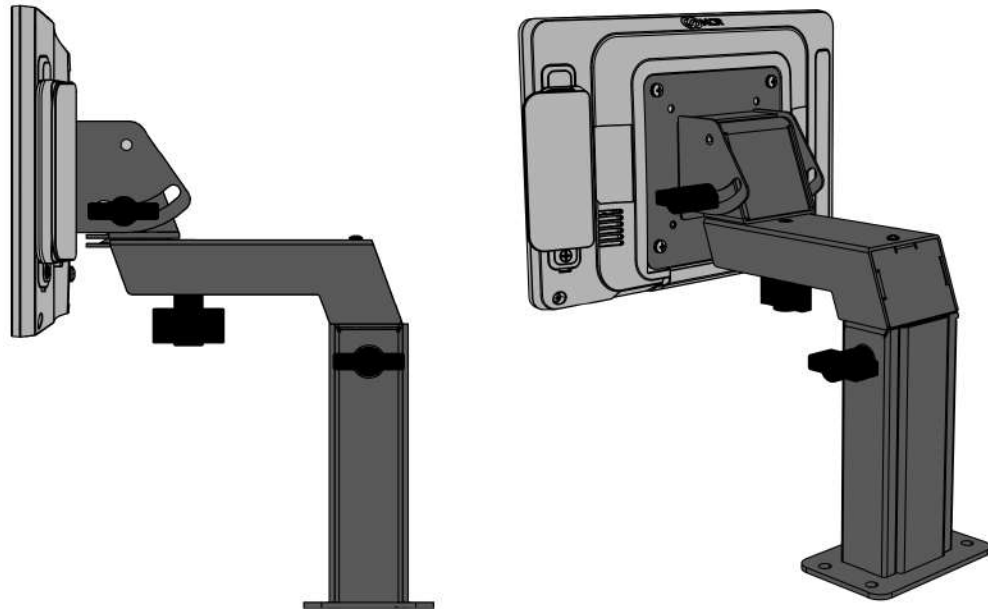

CCP-72307

Wall Mount (7702-K320)

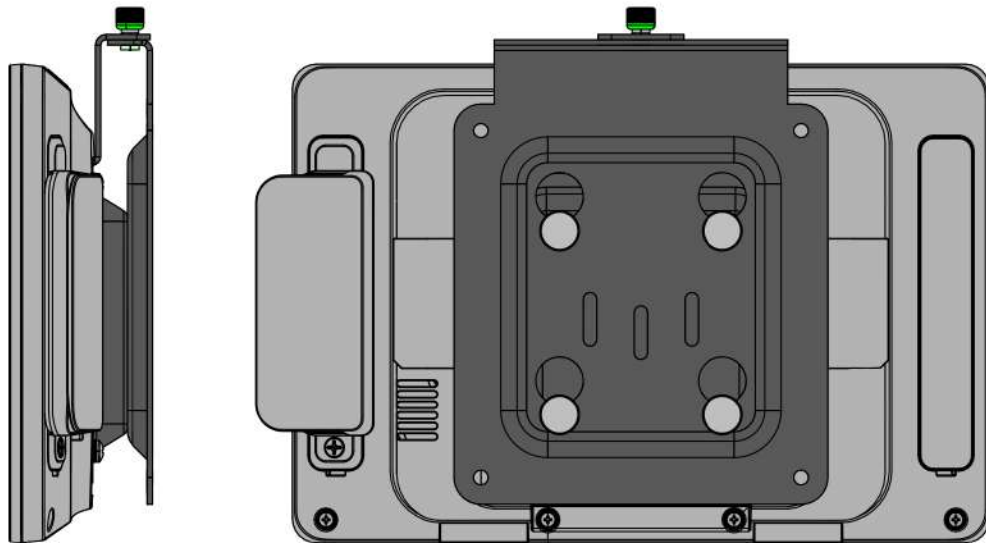

CCP-72308

Third Party Mount

Quick Release Bracket (5915-K320)

Quick release bracket for easy cable access for third party mounts. The bracket provides hooks and two mounting points, and replaces the standard four mounting points on third party pole arms.

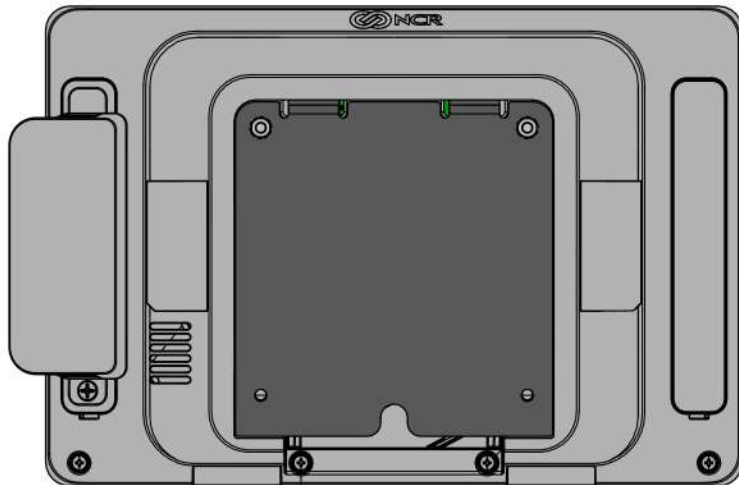

CCP-72309

Magnetic Stripe Reader (5910-F141, 5910-F241)

The NCR XL10W (5910) provides an integrated 3-track ISO MSR option. The MSR is mounted on the right side of the display. When the MSR is not installed, a cover for the MSR location is provided. The MSR interfaces to the system via USB connection.

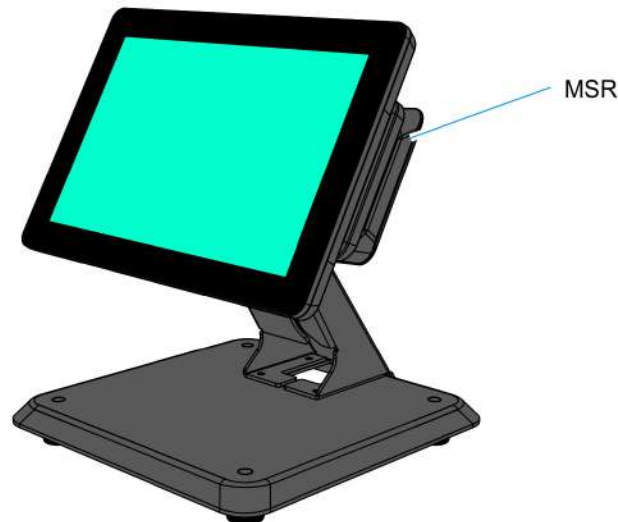

CCP-72993

Data Encryption

The NCR Encrypted MSR head encrypts card data on the head using a Triple DES DUKPT encryption scheme. The data is encrypted using the 3DES standard. A unique 3DES key is generated for every transaction (no two swipes are encrypted with the same 3DES key). The data is decrypted before it is sent to the application.

Card Data Encoding

Card data should be encoded according to the ISO Standards 7810, 7811 and 7813. In particular, 7810 describes the physical dimensions and layout of the card and mag stripe. 7811-4, 5 and 6 relate to the locations and magnetic characteristics of track data in the mag stripe. 7813 is specific to financial cards (credit and debit).

- Track 1 data is 7-bit encoded, alphanumeric and a maximum of 79 characters.
- Track 2 data is 5-bit encoded, numeric only and a maximum of 40 characters.
- Track 3 data is 5-bit encoded, numeric only and a maximum of 107 characters.

See the ISO Standards specifications for more detail.

Card Thickness

The MSR module accepts standard cards within the thickness range of 0.68 – 0.84 mm.

Cube Scanner (5910-F173)

The Cube Scanner is mounted on the left side of the display. When the Scanner is not installed, a cover for the scanner location is provided. The Cube Scanner interfaces to the system via USB connection.

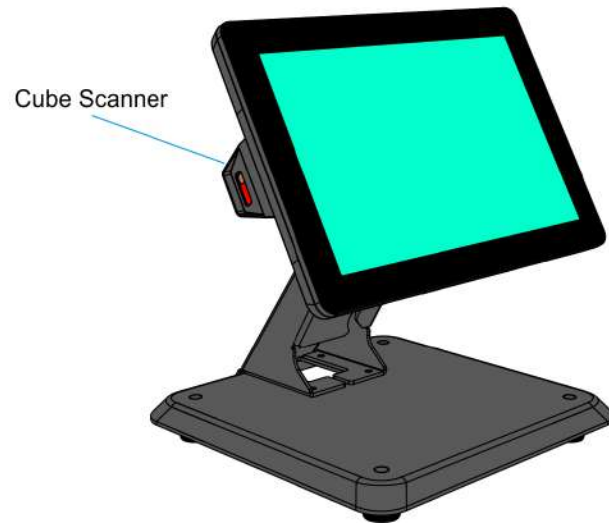

CCP-72994

Miscellaneous Kits

5910-F302/K302

Bracket to mount Non-Touch NCR XL10W (5910) to pole.

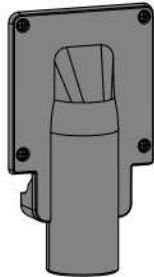

CCP-72360

5915-K470

Bracket to mount NCR XL10W (5910) to the neck of the XL Stand (5910-F033) as a customer display. Kit includes mounting screws.

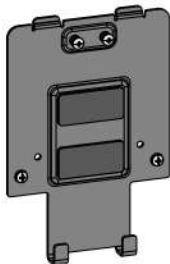

CCP-72361

7613-K470

Bracket to mount NCR XL10W (5910) as a customer display to NCR XR3 (7613) neck. Kit includes mounting screws.

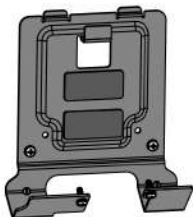

CCP-72362

7702-K470

Bracket to mount NCR XL10W (5910) as a customer display to X-Series Stand (7702-K031) or P-Series Stand (7761-K170) neck. Kit includes mounting screws.

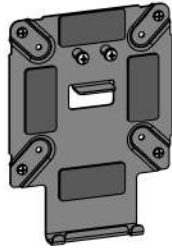

CCP-72363

Label Locations

Display Port Model

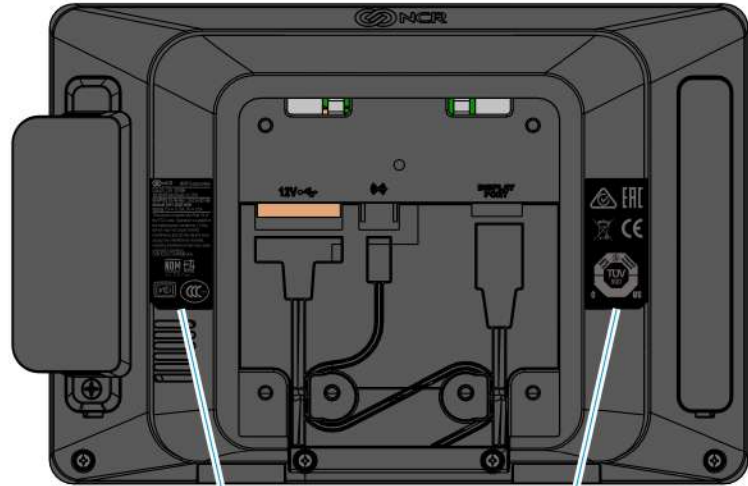

Certification/Feature Label

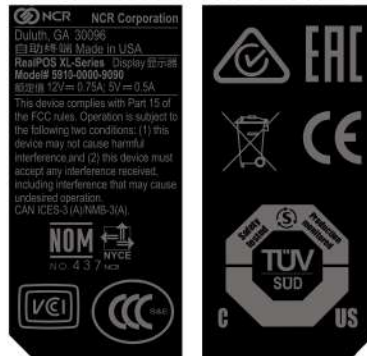

Serial Number Label



Model Number Label



USB Model

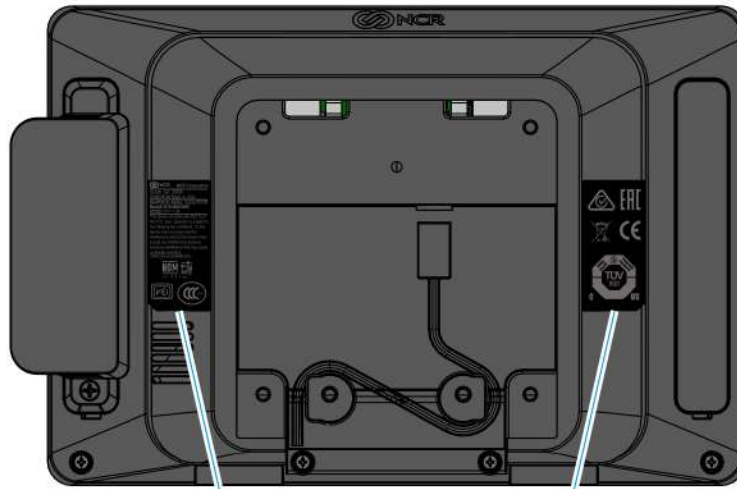

Certification/Feature Label

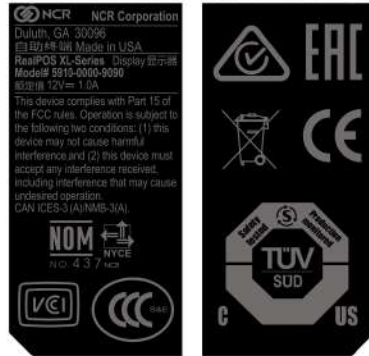

Serial Number Label



Model Number Label



Chapter 2: Hardware Installation

Installation Restrictions

Before installing the NCR XL10W (5910) Display, read and follow the guidelines in the NCR XL10W (5910) Site Preparation Guide and the NCR Workstation and Peripheral AC Wiring Guide (BST0-2115-53).

- Install the display near an electrical outlet that is easily accessible. Use the power cord as a power disconnect device.
- Do not permit any object to rest on the power cord. Do not locate the display where the power cord can be walked on.
- Use a grounding strap or touch a grounded metal object to discharge any static electricity from your body before servicing the display.



Caution: This device should only be powered by a power supply source which meets Safety Extra Low Voltage (SELV) and LPS (Limited Power Source) requirements per UL1950, IEC 950, and EN 60 950. The power source must be certified by the appropriate safety agency for the country of installation.



Caution: Use a grounding strap when installing this feature.

Ergonomic Workplace

The NCR XL10W (5910) has a high brightness LCD, please observe the following when considering the terminal workplace:

- Avoid direct glaring and reflective glaring light. Locate the terminal in a controlled luminance surrounding. When installed next to windows orient the terminal so it does not reflect the outside light.
- If possible, avoid reflective glaring caused by electric light sources.
- Position the terminal for ideal viewing angles.

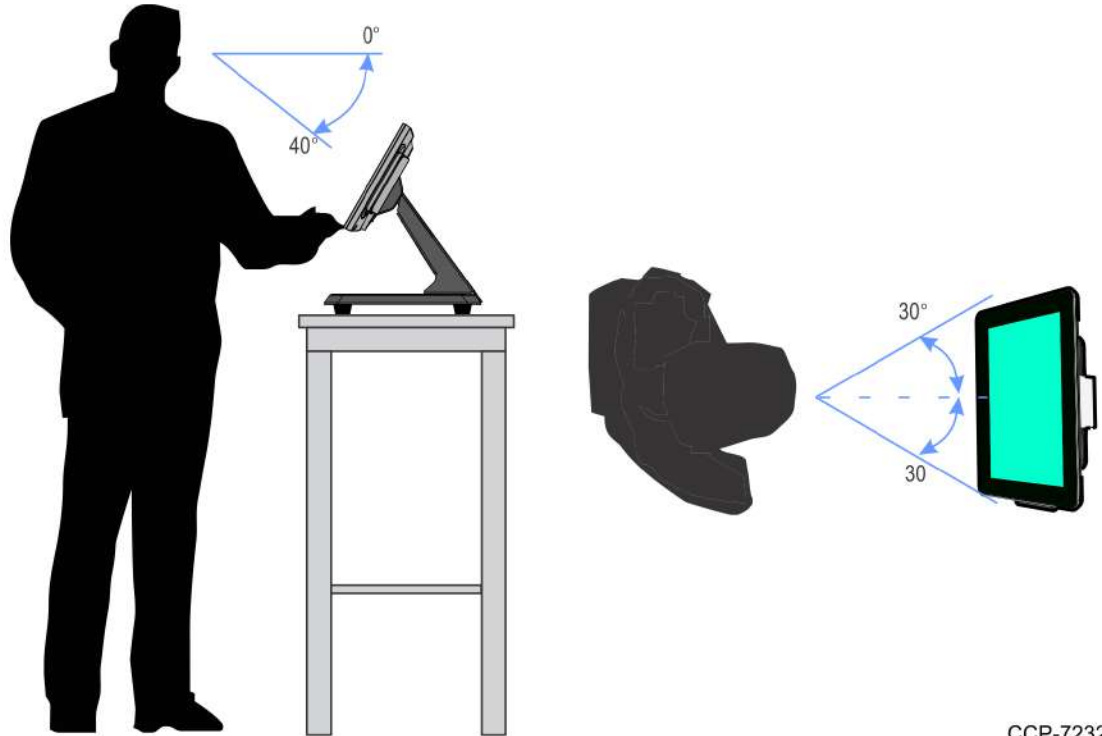

Installing the Display

The NCR XL10W (5910) Display can be mounted using a variety of mounts:

- XL10W Wedge Stand (5910-F030/K030)
- XL-Series Stand (5910-F033/K033, 5915-F233)
- XL10W Pole Mount (5910-F302/K302)
- Wall Mount (7702-K320)
- Integration Tray Mount (5968-K024)
- X-Series Table Top Stand (5968-K031)
- Checkstand Mount (5968-K039)
- Third-Party VESA Mounts

This chapter explains how to perform an "Out-of-box" installation of the NCR XL10W (5910) Display mounted on the [XL-Series Stand](#), on the [XL10W Wedge Stand](#), on the [XL10W Pole Mount](#), and how to [connect cables to a POS terminal](#). For installation procedures for the other mounting options see their associated kit instructions.

Installing the Display to the XL-Series Stand

1. Connect the Display cables and route them according to the imprinted routing guide.

Display Port Model

- a. Connect and route the Audio Cable first. Route the cable looping around the cable strain relief posts as shown.
- b. Connect the Display Power Cable and route straight down over the Audio Cable.
- c. Connect the Display Port Cable and route straight down over the Audio Cable.

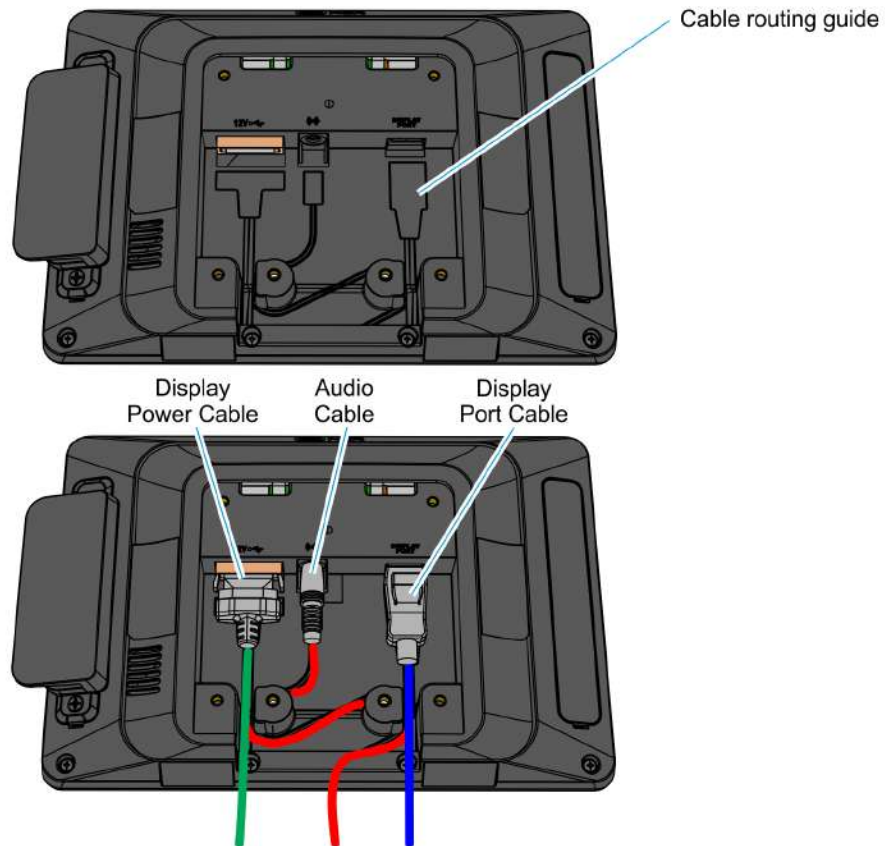

USB Model

- a. Connect and route the USB Cable looping around the cable strain relief posts as shown.

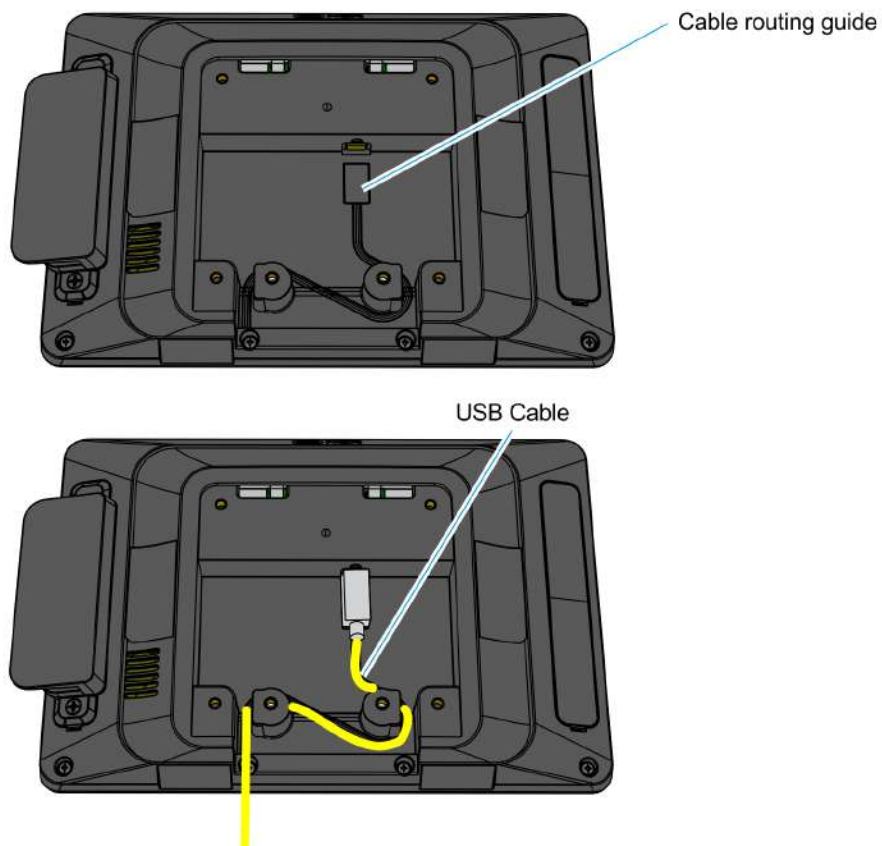

2. Mount the XL-Series Stand on the Display.
 - a. Insert the Mounting Bracket tabs into the slots in the rear of the Display and then slowly rotate the stand assembly downward.

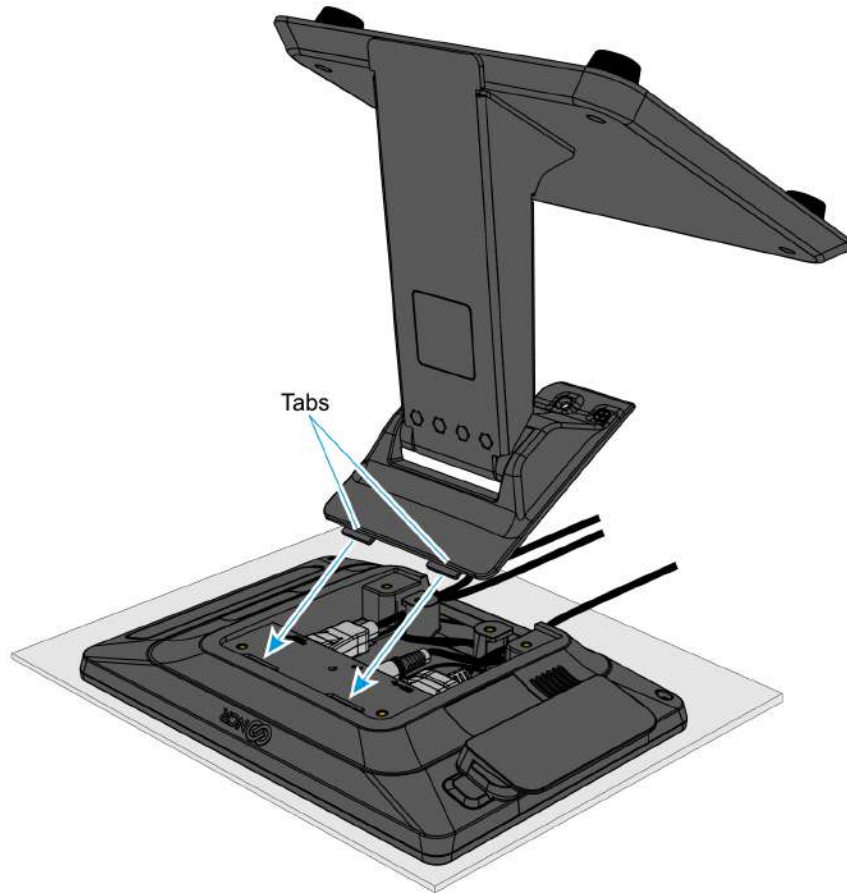

CCP-72325

- b. Rotate the Stand to the orientation shown below.



CCP-72326

3. Gently push the Stand assembly forward to properly align its mounting holes with the display. Secure the Stand with screws (2).

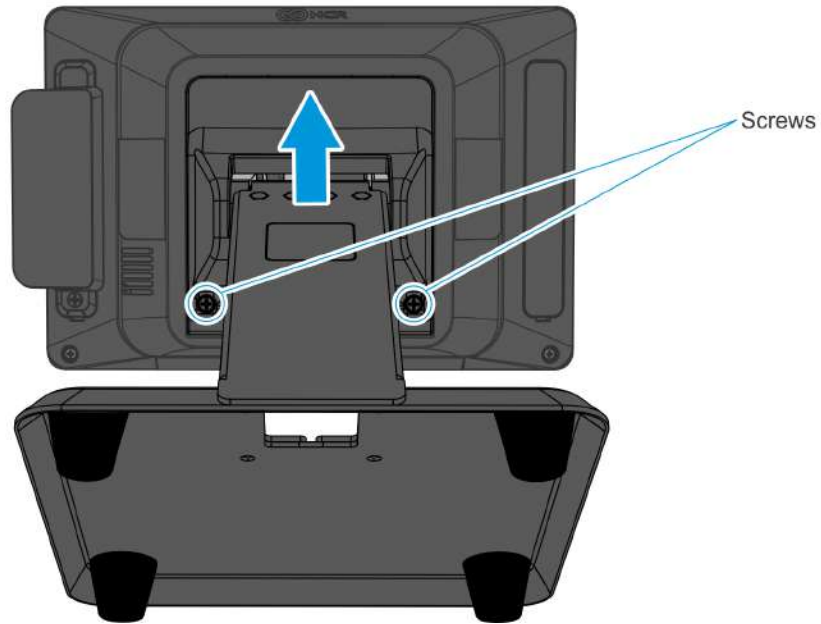

CCP-72327

4. Pivot the Stand towards the back as shown.

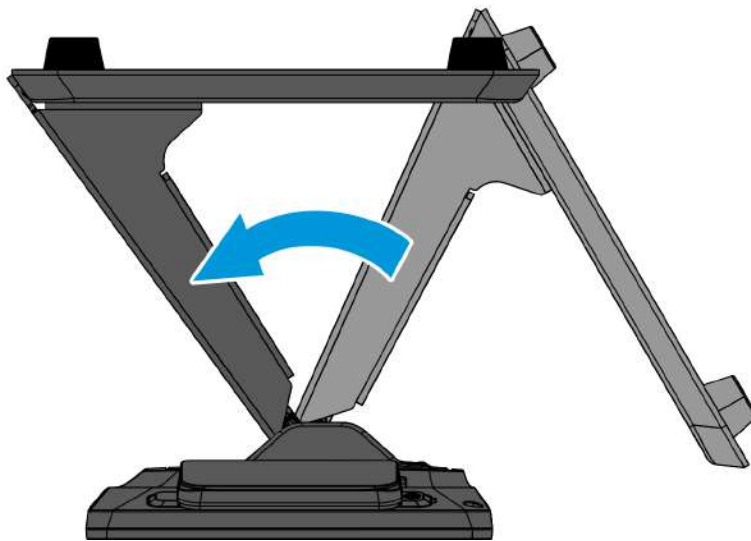

CCP-72328

5. Route and secure the Display cables to the Mounting Bracket.

Display Port Model

- a. Route the Audio Cable first to the left slot and make sure it is behind the tab in the slot.
- b. Route the Display Port Cable to the left slot and make sure it is behind the tab in the slot.
- c. Route the USB Cable to the right slot and make sure it is behind the tab in the slot.

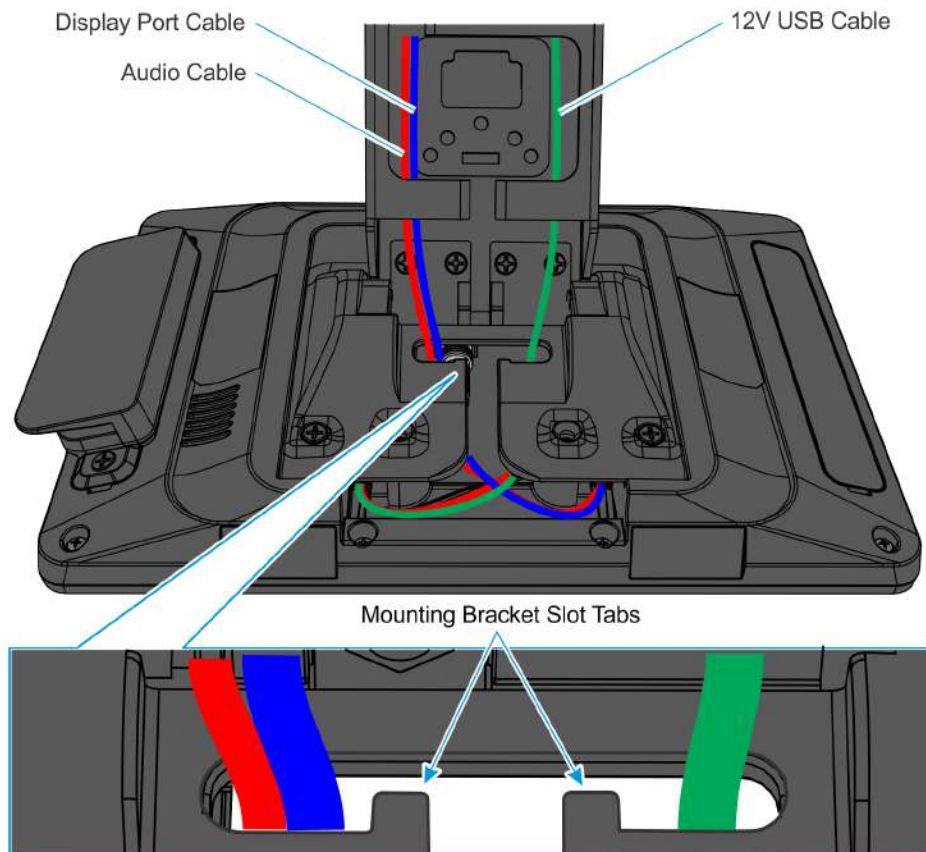

USB Model

- a. Route the USB Cable to the right slot and make sure it is behind the tab in the slot.

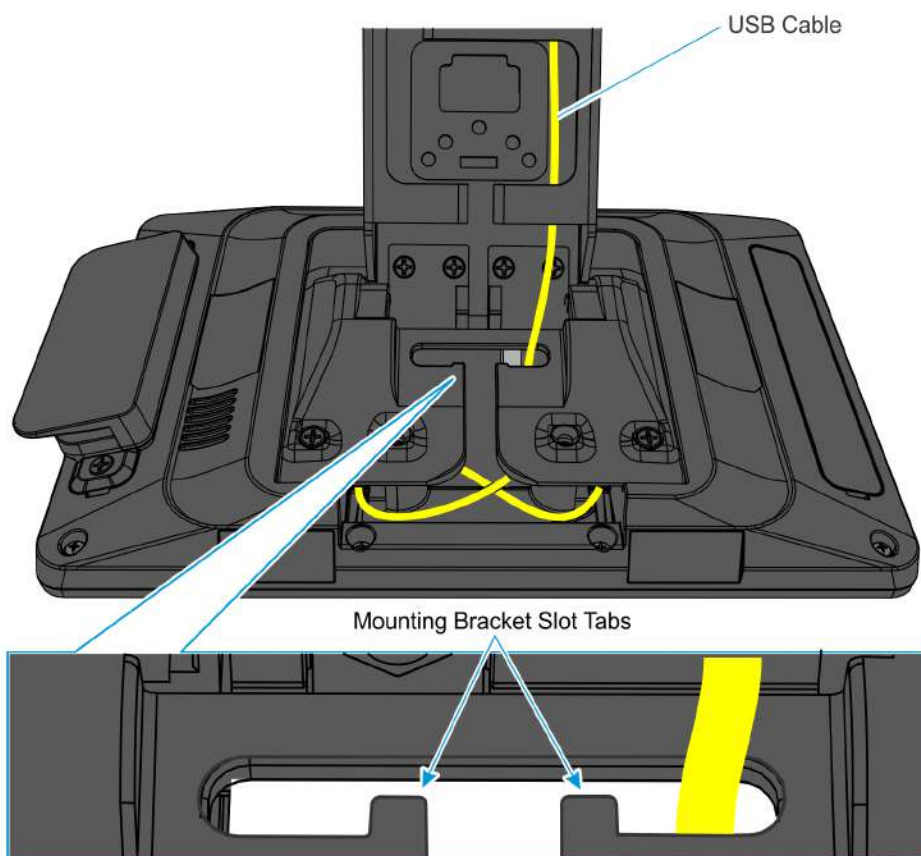

- Route the cables through the neck slot then push cables through the curved neck opening and then out the base opening.

Display Port Model — Align the Audio Cable and Display Port Cable to the left side and the 12V USB Cable to the right side.

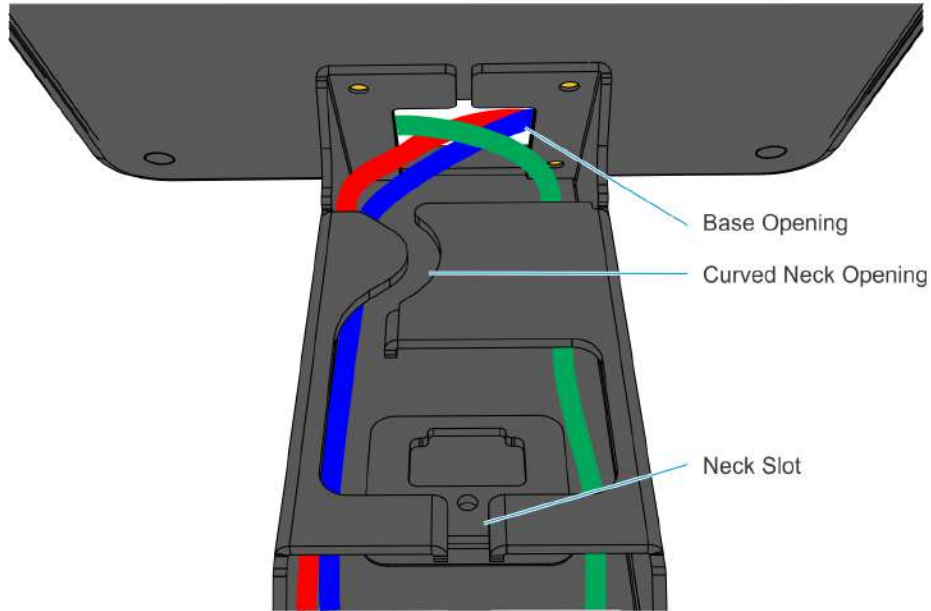

CCP-72332

USB Model — Align the USB Cable to the right side.

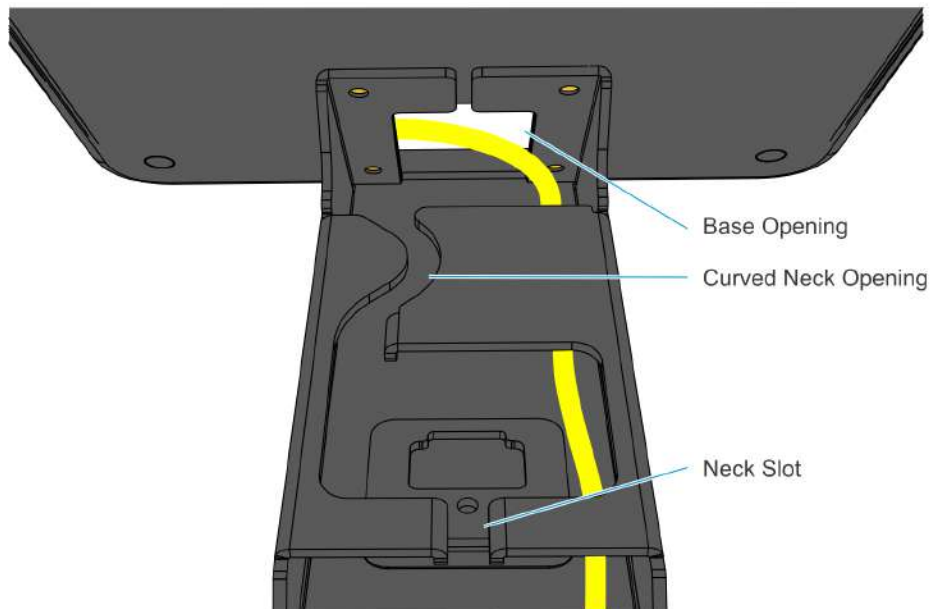

CCP-72333

- Pull cables such that most of the cables have been fed through the base opening.

8. Position the display and stand assembly in an upright position.



CCP-72331

Installing the Display to the XL10W Wedge Stand

1. Remove the Cover from the Wedge Stand.
 - a. Swing the Cover upward to detach. The Cover has a snap fit connection on the bottom.
 - b. Pull Cover in the direction shown to unlatch.

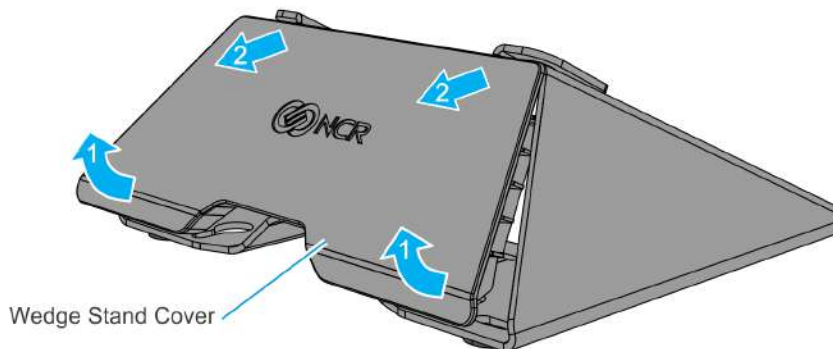

CCP-72967

2. Connect the Display Cables and route them as shown.

Display Port Model

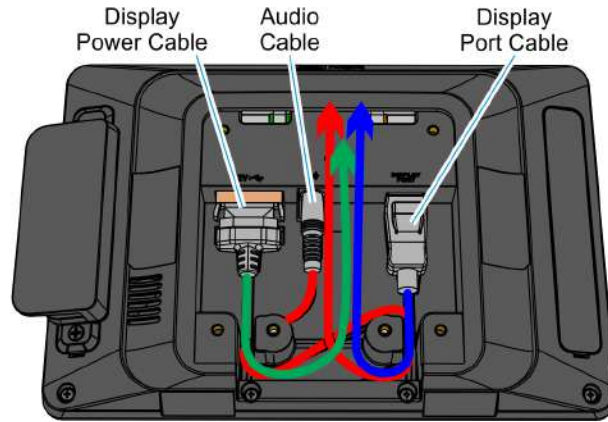

CCP-72980

USB Model

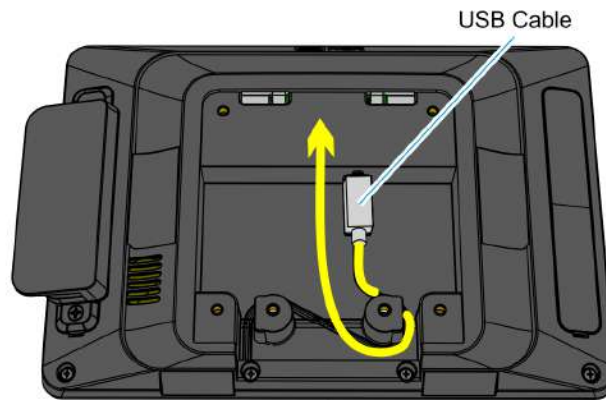

CCP-72981

3. Install the Wedge Stand on the back of the Display (4 screws).

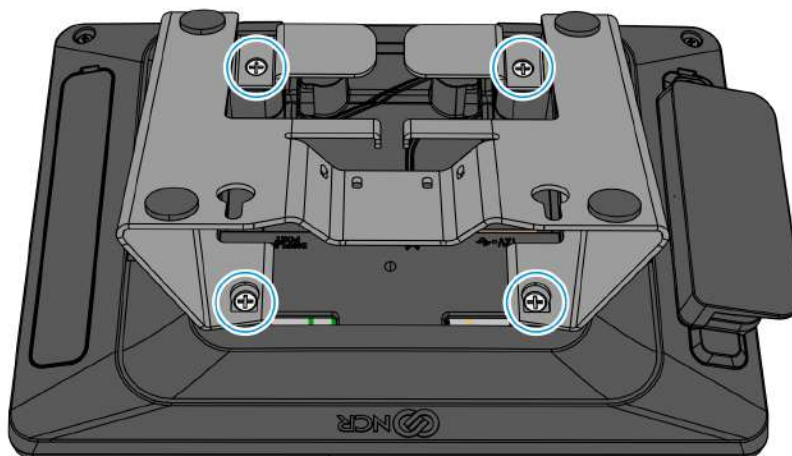

CCP-72968

4. Route the Cables through the slot between the tabs and make sure the Cables are behind the tabs.

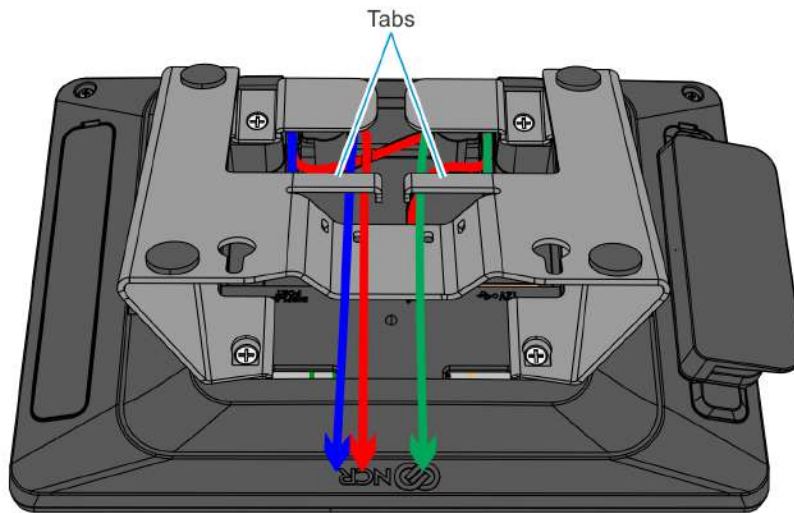

CCP-72982

5. Reinstall the Wedge Stand Cover.
 - a. Insert the tabs of the Cover into the Wedge Stand.
 - b. Swing the Cover down until it latches into place.

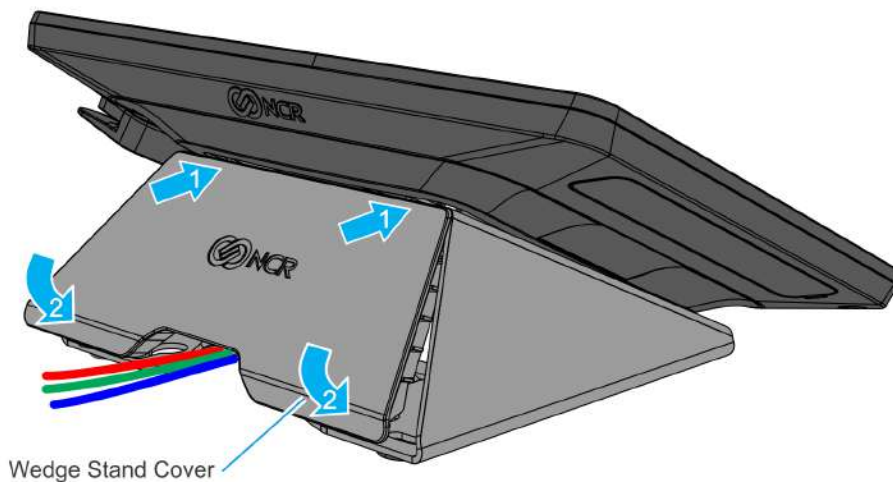

CCP-72969

6. Connect the Display Cable(s) to the host terminal.

Installing the Display to the XL10W Pole Mount

1. Connect the Display cables and route them according to the imprinted routing guide.

Display Port Model

- a. Connect and route the Audio Cable first. Route the cable looping around the cable strain relief posts as shown.
- b. Connect the Display Power Cable and route straight down over the Audio Cable.
- c. Connect the Display Port Cable and route straight down over the Audio Cable.

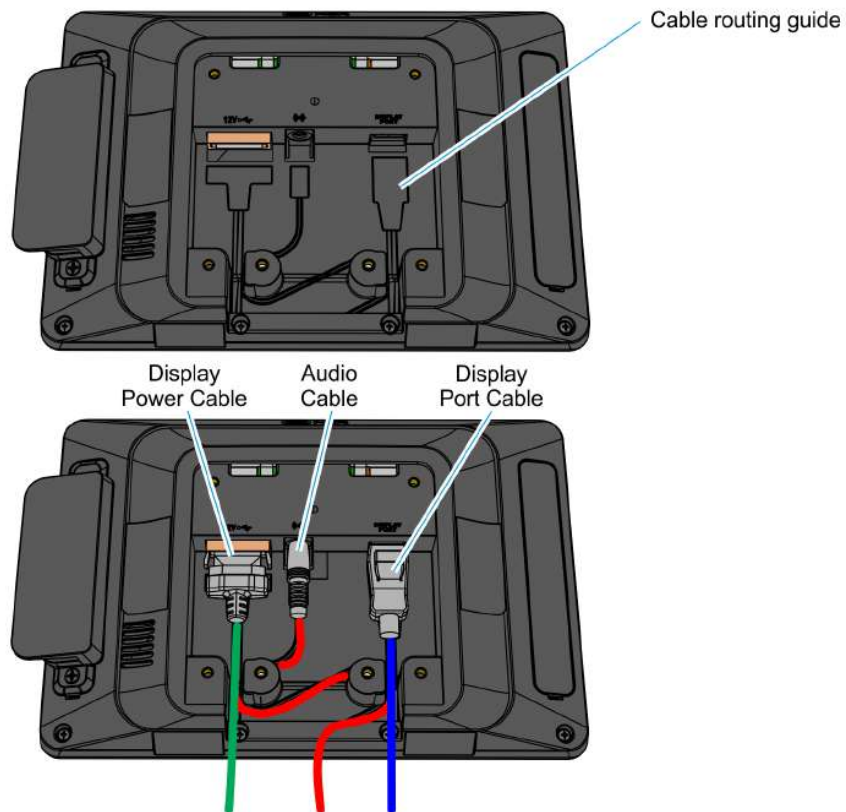

USB Model

- a. Connect and route the USB Cable looping around the cable strain relief posts as shown.

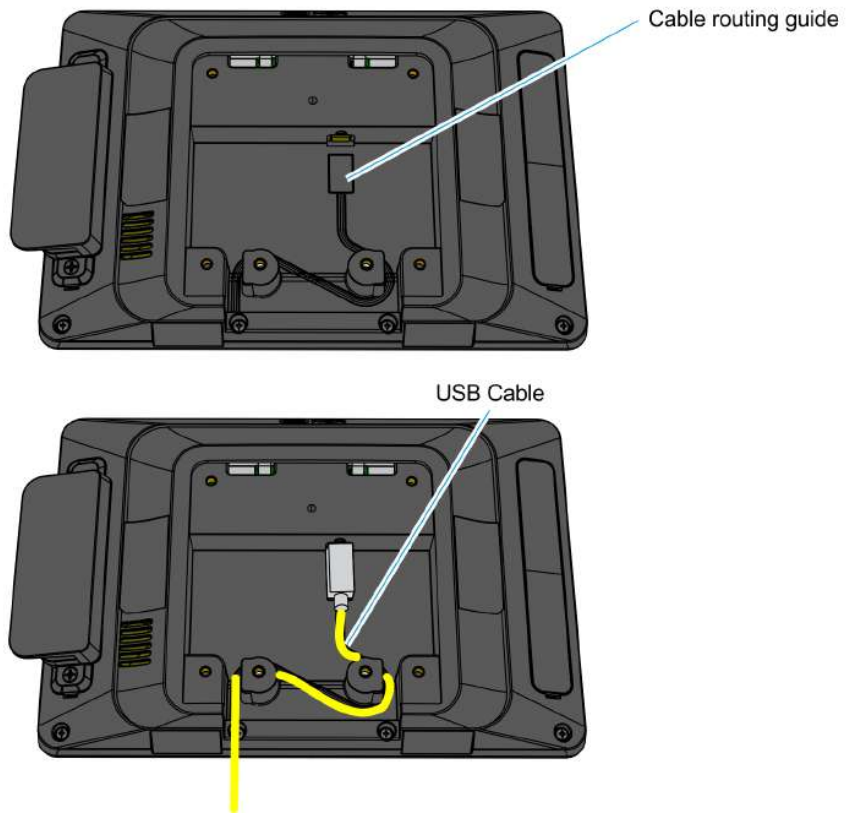

CCP-72324

2. Insert the cable(s) through the Bracket opening.

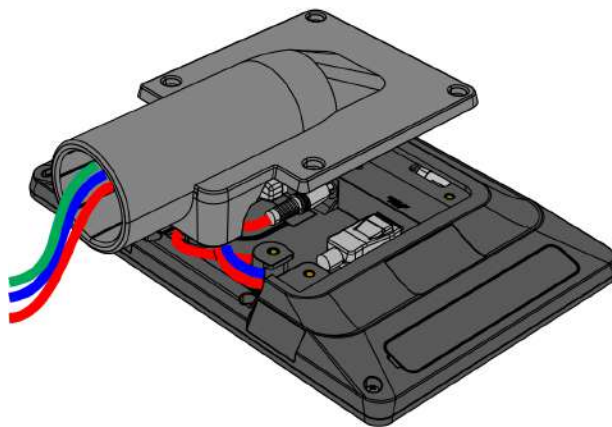

CCP-72365

3. Install the Bracket on the back of the Display (4 screws).

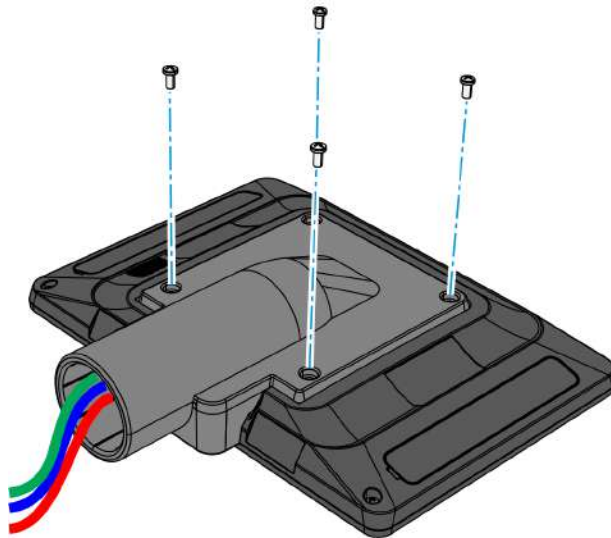

CCP-72366

4. Insert the cable(s) through the Pole.

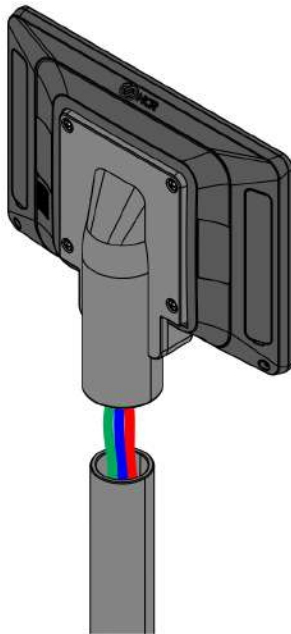

CCP-72367

5. Mount the Display on the Pole.

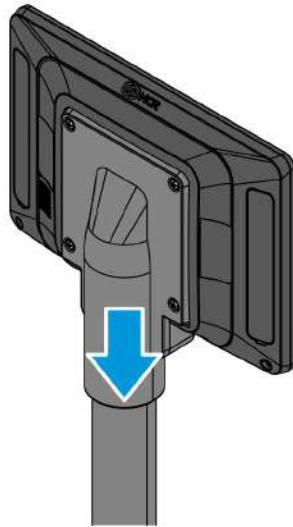

CCP-72368

6. Connect the Display Cable(s) to the host terminal.

Connecting to a POS Terminal

The following illustrations show the host terminal cable connections.

Display Port Model

The required cables vary depending on the available video connectors on the host terminal.

Display Port Cables

The Display Port Cable provides video to the display.

- Connect the Display Port Cable to the Display Port connectors on both the display and the terminal.

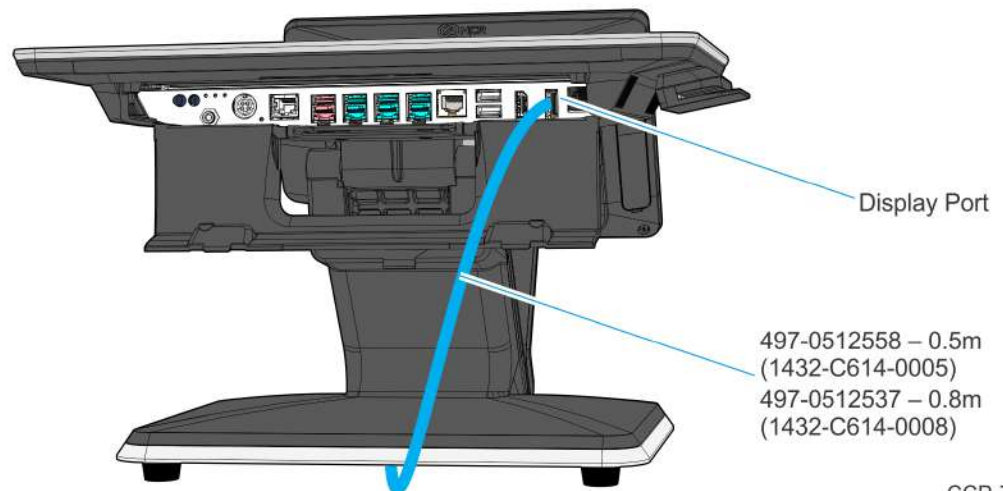
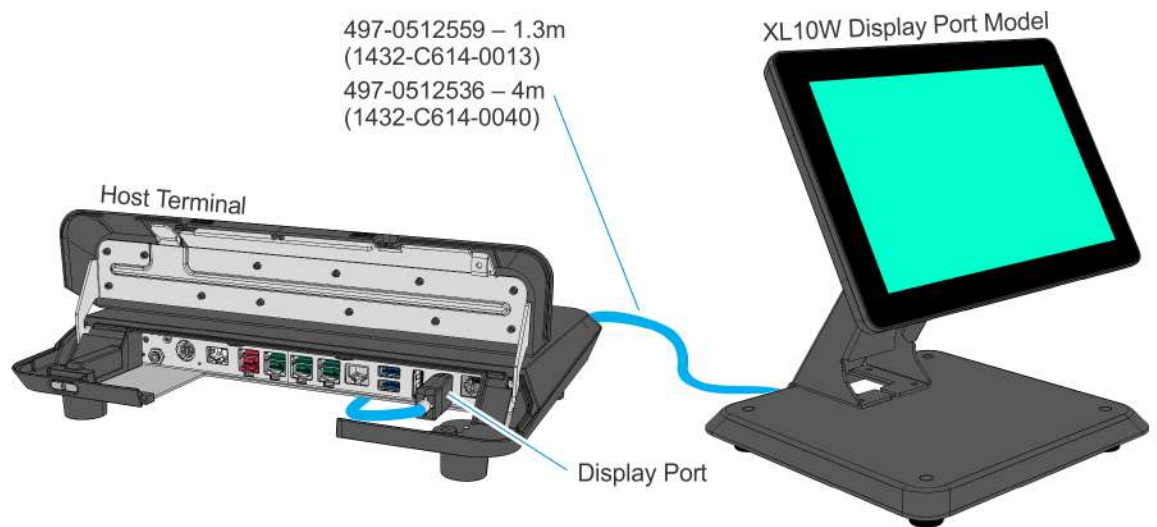

External Power Cables

An External Power Cable provides both USB and power to the display when the host terminal does not have a USB 12V port available, but does have an available standard USB port.

1. Connect the External Power Cable to the display Power connector.
2. Connect the other end of the External Power Cable to the USB connector on the host terminal.
3. Connect the Power Adapter DC Cable to the External Power Cable (middle of cable).
4. Connect the AC Power Cord to the Power Adapter and an AC outlet.

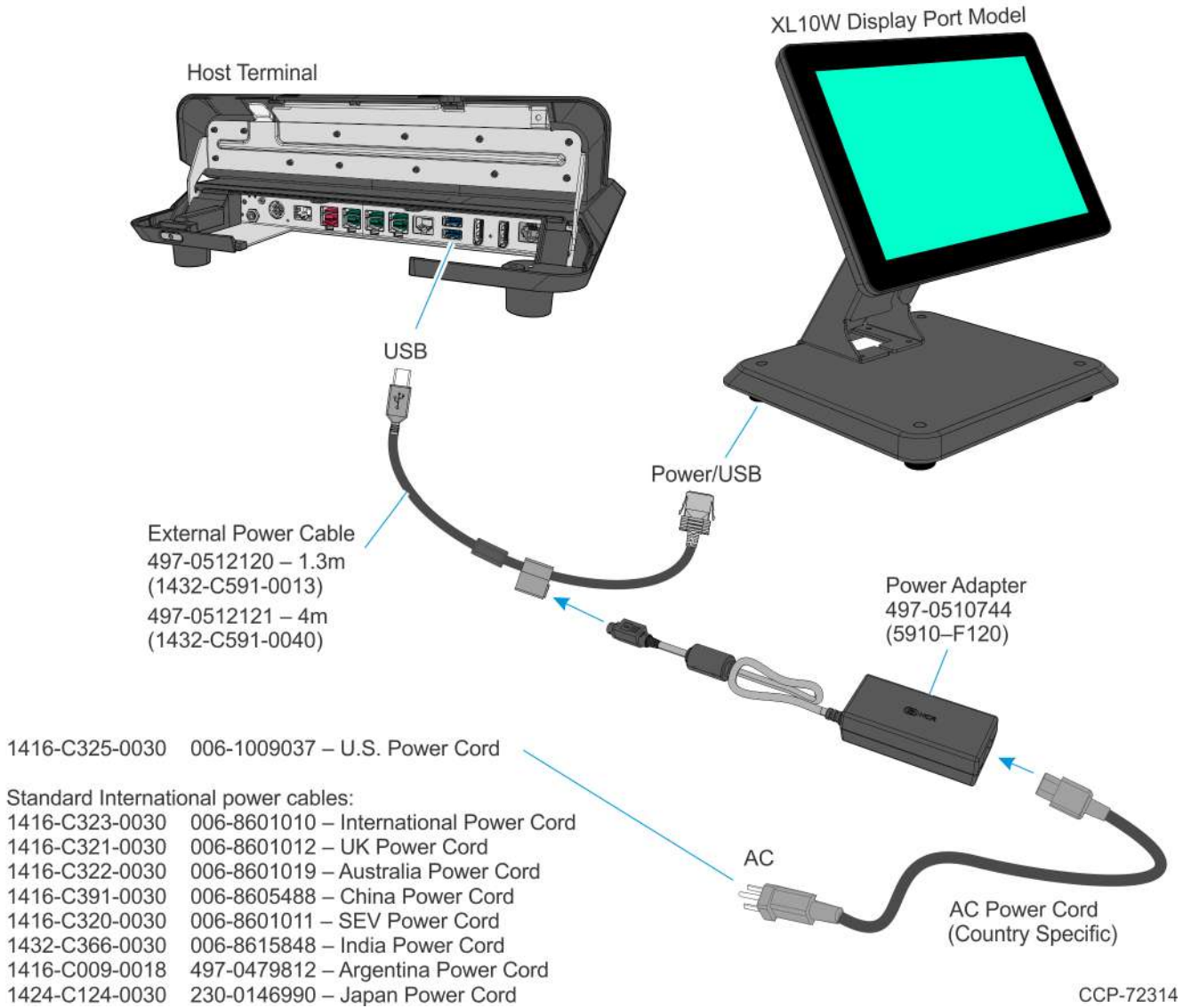

Powered USB Cables

The Powered USB Cable provides both USB and power to the display.

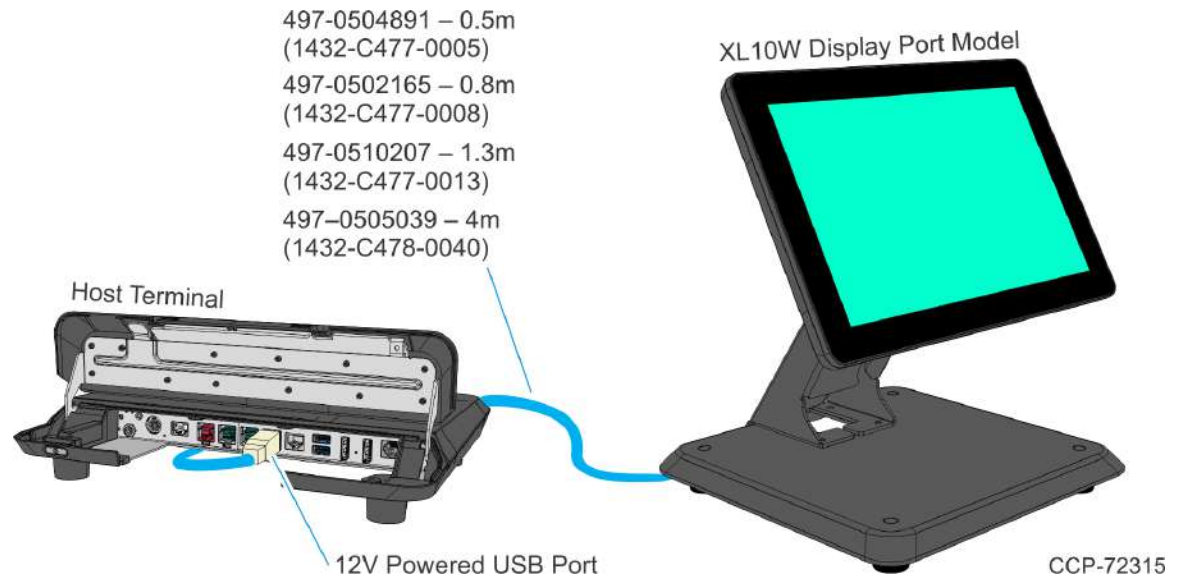

Audio Cable

The Audio Cable provides audio to the display.

- Connect the Audio cable to the Audio Port connectors on both the display and the terminal.

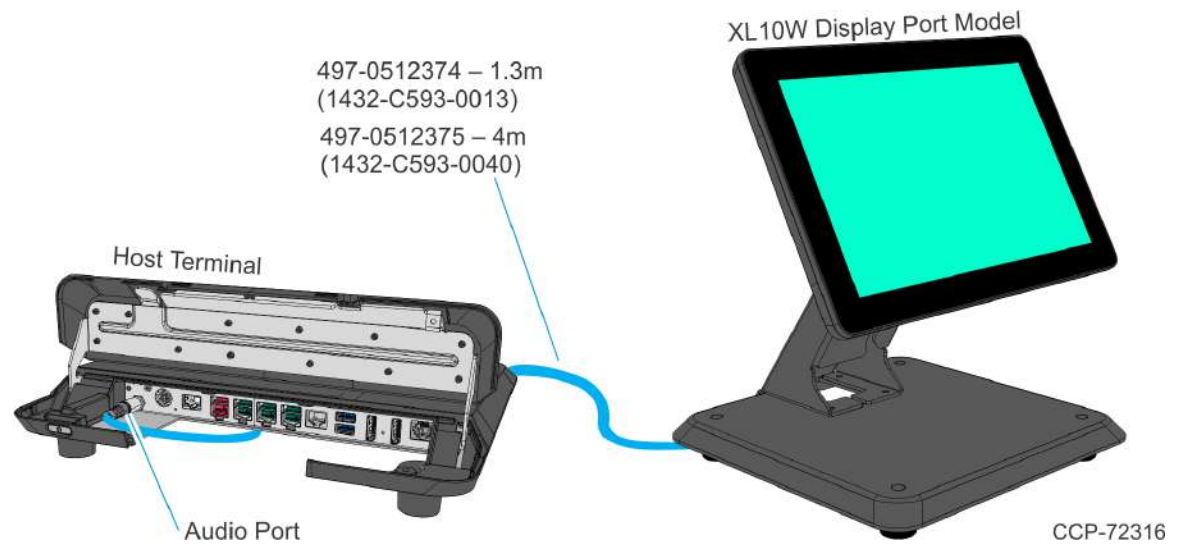

Adapters

HDMI to Display Port Adapter

The HDMI to Display Port Adapter allows connection of a display with Display Port to a host terminal with an HDMI connection. The adapter must be used with a Display Port Cable.

1. Connect the Display Port Cable to the display.
2. Connect the other end of the Display Port Cable to the Display Port connector of the HDMI to Display Port Adapter.
3. Connect the HDMI connector of the Adapter to the HDMI port of the host terminal.
4. Connect the USB connector of the Adapter to any available USB port on the host terminal.



Note: The HDMI to Display Port Adapter includes a USB extension cable in case the USB cable of the Adapter is not long enough to reach the desired USB port.

DISPLAY PORT ADAPTER AND EXTERNAL POWER SUPPLY CONFIGURATION

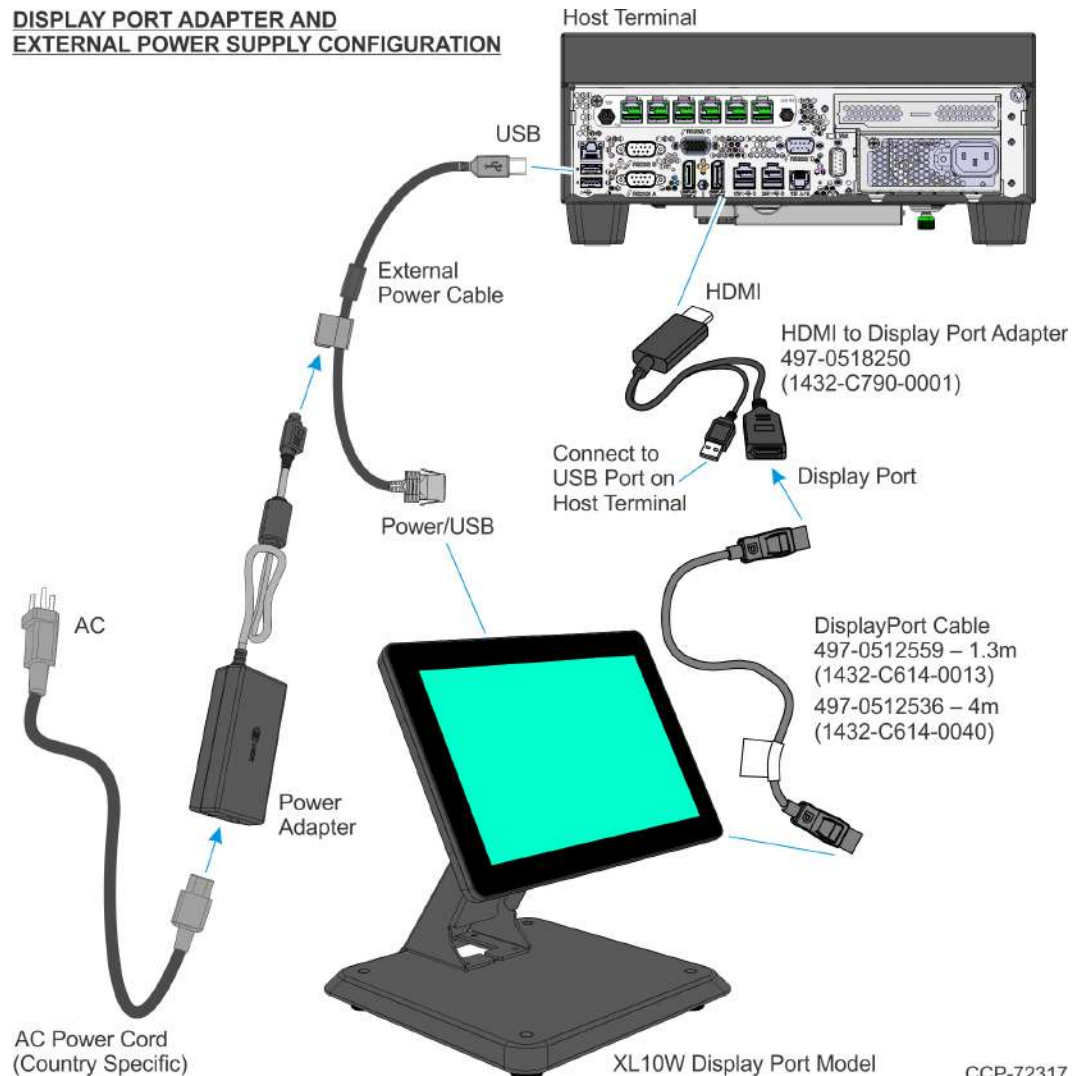

DVI-D to HDMI Adapter

The DVI-D to HDMI Adapter allows connection of a display with Display Port to a host terminal with a DVI connection. The adapter must be used with a Display Port Cable and an HDMI to Display Port Adapter.

1. Connect the Display Port Cable to the display.
2. Connect the other end of the Display Port Cable to the Display Port connector of the HDMI to Display Port Adapter.
3. Connect the HDMI connector of the HDMI to Display Port Adapter to the HDMI end of the DVI-D to HDMI Adapter.
4. Connect the DVI end of the DVI-D to HDMI Adapter to the DVI port of the host terminal.
5. Connect the USB connector of the Adapter to any available USB port on the host terminal.



Note: The HDMI to Display Port Adapter includes a USB extension cable in case the USB cable of the Adapter is not long enough to reach the desired USB port.

HOST TERMINAL WITH A DVI CONNECTION

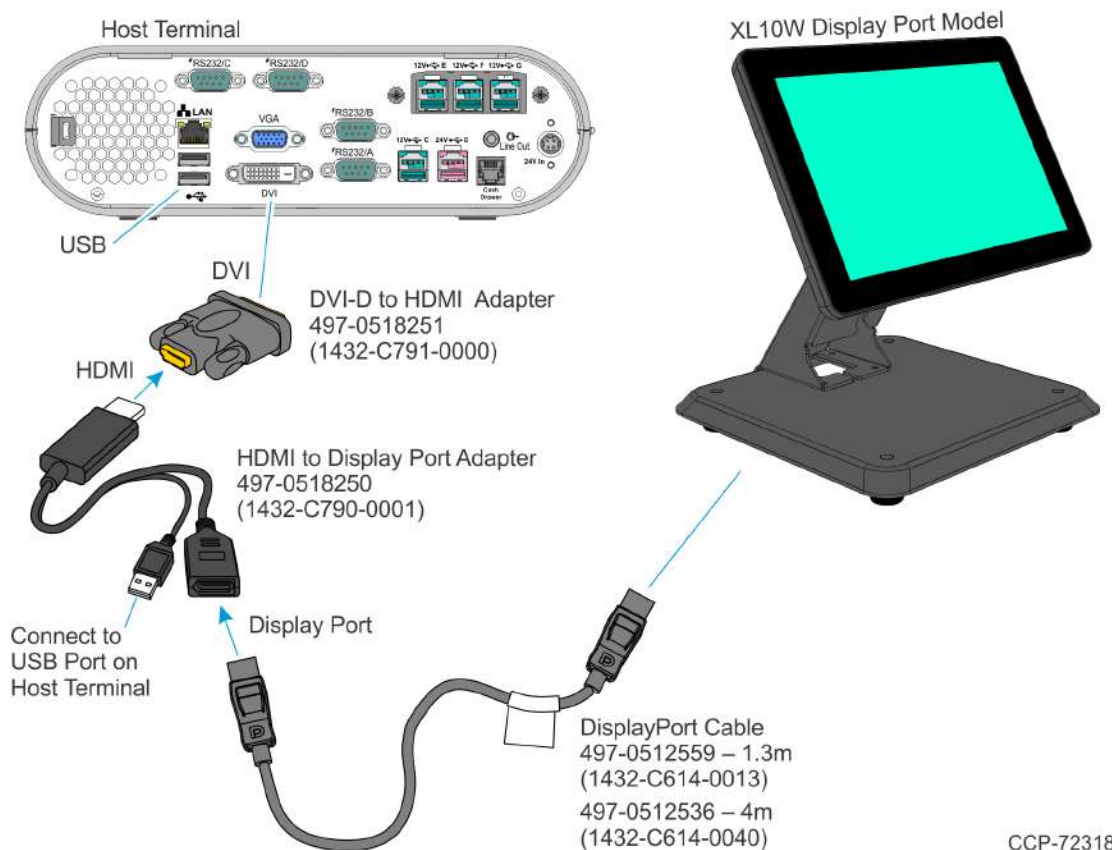

DISPLAY PORT ADAPTERS AND EXTERNAL POWER SUPPLY CONFIGURATION

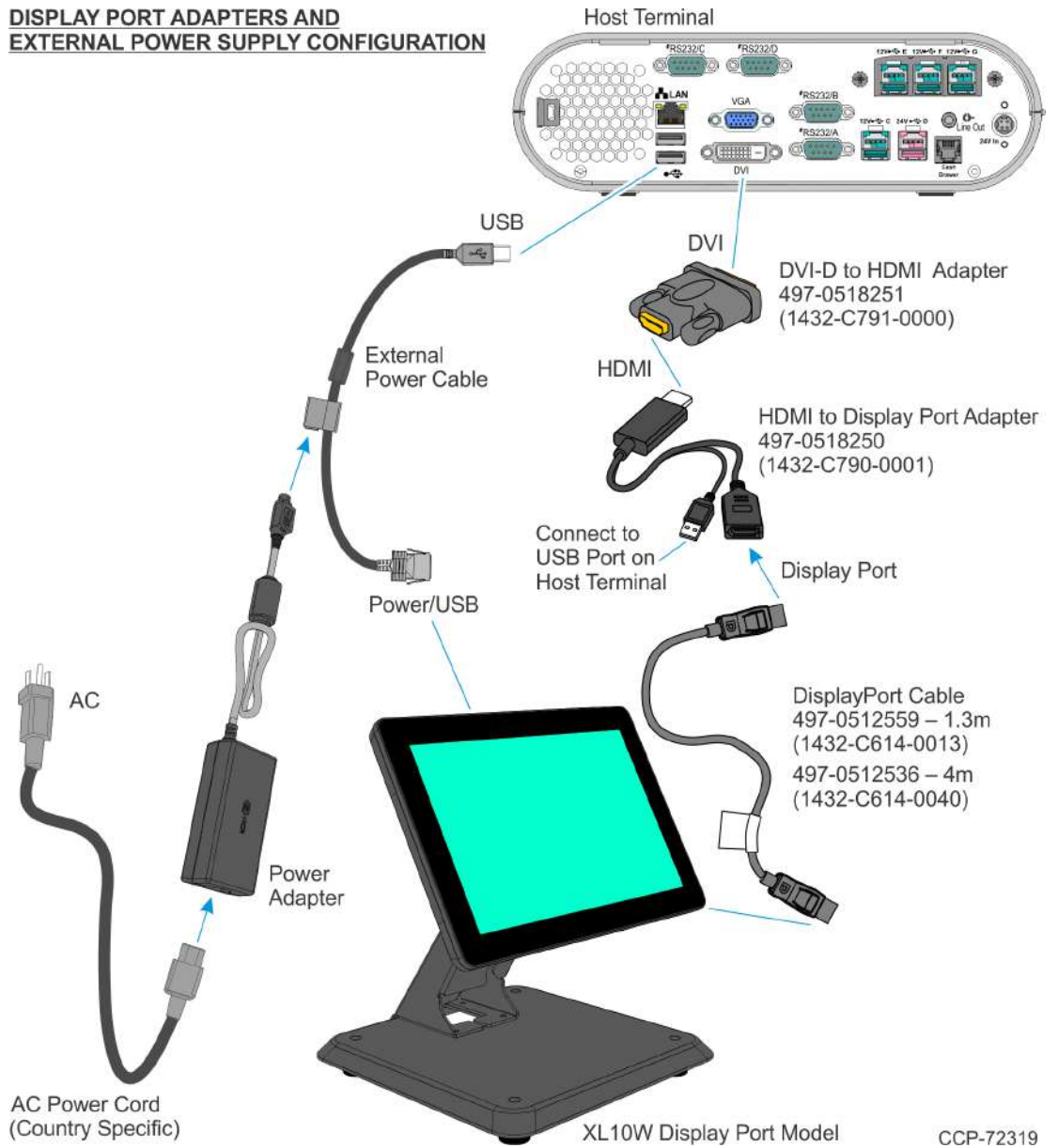

USB Model

USB Cable

The USB Cable provides power, video, and audio to the display.

- Connect the USB cable to the USB Port connectors on both the display and the terminal.

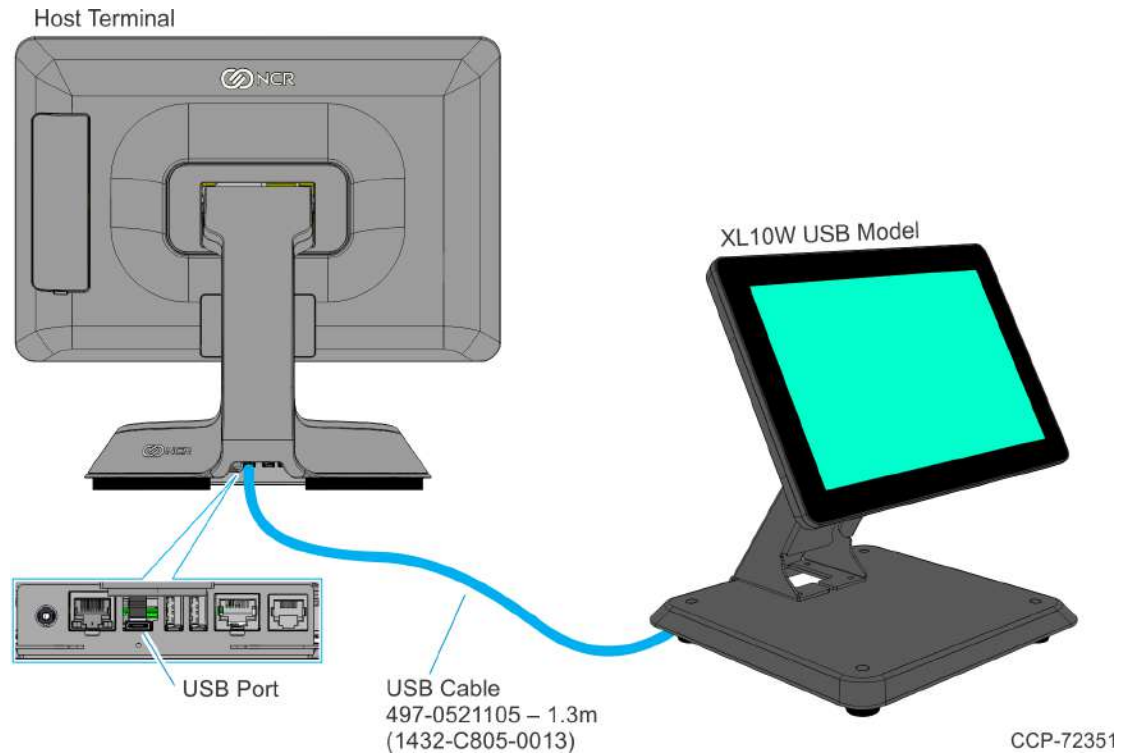

Chapter 3: Operation and Cleaning

Projected Capacitive Touchscreen

PCAP touchscreens have all the benefits of normal capacitive touchscreens and more:

- Fast processing of touch information
- High sensitivity (use conductive pencils, with hands, and with thin gloves)
- Multi-touch capability (10-finger)
- High resolution
- Improved legibility and display brightness due to optimal light transmission

In addition, the technology of PCAP touchscreens is characterized by significantly higher robustness and stability than common capacitive touchscreens because the active touch surface is located on the back side of the touchscreen instead of the front side. Therefore, the active surface is not directly touched and does not wear off by normal use.

Since most surface contamination do not cause interference to the touchscreen the NCR XL10W (5910) can be used in public or severe environmental conditions.

Using the PCAP Touchscreen

The PCAP touchscreen responds to the lightest touches. Touching with a single finger resembles the left mouse button. Two fingers are used to zoom IN (fingers brought together) or zoom OUT (fingers pulled apart). Circular motion can be used to rotate an element on the screen. This function must be supported by either the Operating System or the application.

Touchscreen Cleaning Procedures

1. Using a soft cloth dampened with isopropyl alcohol or a mild non-abrasive soap & water solution, gently wipe the touchscreen clean.
2. Wipe the screen and edges dry.
3. Make sure the glass and screen edges dry completely before using the unit.
4. Do not use sharp objects to clean around the edges of the touchscreen

Magnetic Stripe Reader

The NCR XL10W (5910) features an ISO 3-Track Encrypted MSR head.

The card reading is bi-directional and is mounted on the right side of the display.

Using the MSR

Swipe the card through the slot in the MSR in a quick and steady movement. The magnetic stripe must be facing up and with the stripe in the slot.

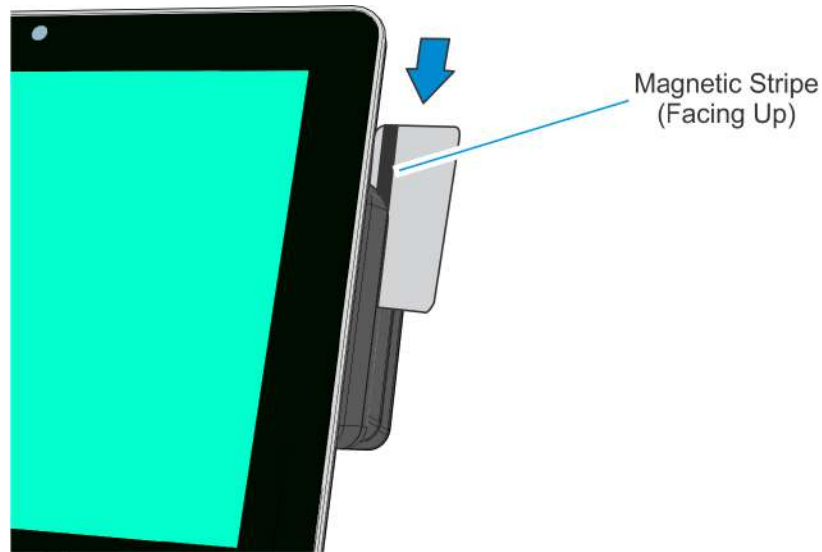

32886

Care of Cards

- Cards should never come in contact with liquids.
- Cards should never be bent or folded in any way.
- Cards should never come in close proximity of a magnetic field.

Card Thickness

The MSR module accepts standard cards within the thickness range of 0.68 – 0.84 mm.

Cabinet Cleaning Procedures

1. Disconnect the unit from the power outlet before cleaning.
2. Use a cloth lightly dampened with a mild detergent.
3. Do not use alcohol (methyl, ethyl, or isopropyl) or any strong dis-solvent. Do not use thinner or benzene, abrasive cleaners, or compressed air.



Warning: Do not use any other types of cleaners such as vinegar, solvents, degreasers, or ammonia-based cleaners. These can damage the unit.

4. Avoid getting liquids inside the unit. If liquid does get inside, have a qualified service technician check it before you power it on again.
5. Remove external dust around the vents.

Chapter 4: NCR Software OSD Utility

Introduction

The NCR Software OSD is an application that is used to adjust display parameters, such as brightness, contrast, and color. It also provides monitor identification information, such as the name, serial number, and manufacturer.

Supported Features



Note: Not all features are supported on every monitor. The button is inactive and grayed out when the feature is not supported

- Brightness
- Contrast
- V Position
- H Position
- Phase
- Clock
- Red/Green/Blue Video Gain
- Color Temperature
- Auto Setup
- Restore Default Settings
- V Moire
- H Moire
- V Size
- H Size

Installing the Utility

1. Download the OSD Utility from the NCR website: <http://www.ncr.com>
 - a. At this site, select the **Support** link on the bottom of the page.
 - b. Select **Drivers and Patches** → **Retail Support Files** → **NCR RealPOS and Peripherals** → **Displays** → **5910**.
 - c. Download the application.

There are several versions to choose from. There are GUI versions that are used to run locally on each system or Console versions for customers who want to run the application from a Command Line to many systems concurrently.

Windows

- *NCR_Software_OSD_GUI_x86* - (32-Bit)
- *NCR_Software_OSD_Console_x86* - (32-Bit)
- *NCR_Software_OSD_GUI_x64* - (64-Bit)
- *NCR_Software_OSD_Console_x64* - (64-Bit)

Linux

- *NCR_Software_OSD_GUI_x86* - (32-Bit)
- *NCR_Software_OSD_Console_x86* - (32-Bit)

2. Click on the version of choice and Save it on your local system.
3. Unzip the application to a folder of your choice on the target system.
4. In the unzipped folder, navigate to the OSD executable.

Example: (32-Bit GUI version)

```
NCR_Software_OSD_GUI_x86_V2.1.7.1 >> x86
```

5. Run the *.exe file.

```
NCR_Software_OSD_GUI_x86.exe >> [Enter]
```

6. Answer **Yes** at the Security warning.

Running the Utility (GUI Version)

1. Unzip the application to a folder of your choice on the target system.
2. In the unzipped folder, navigate to the OSD executable.

Example: (32-Bit version)

[NCR_Software_OSD_GUI_x86_V2.1.6.3](#)>> x86

3. Execute the **[NCR_Software_OSD_GUI_x86.exe](#)** file to start the application.
4. Answer **Yes** at the Security warning.

Main Menu

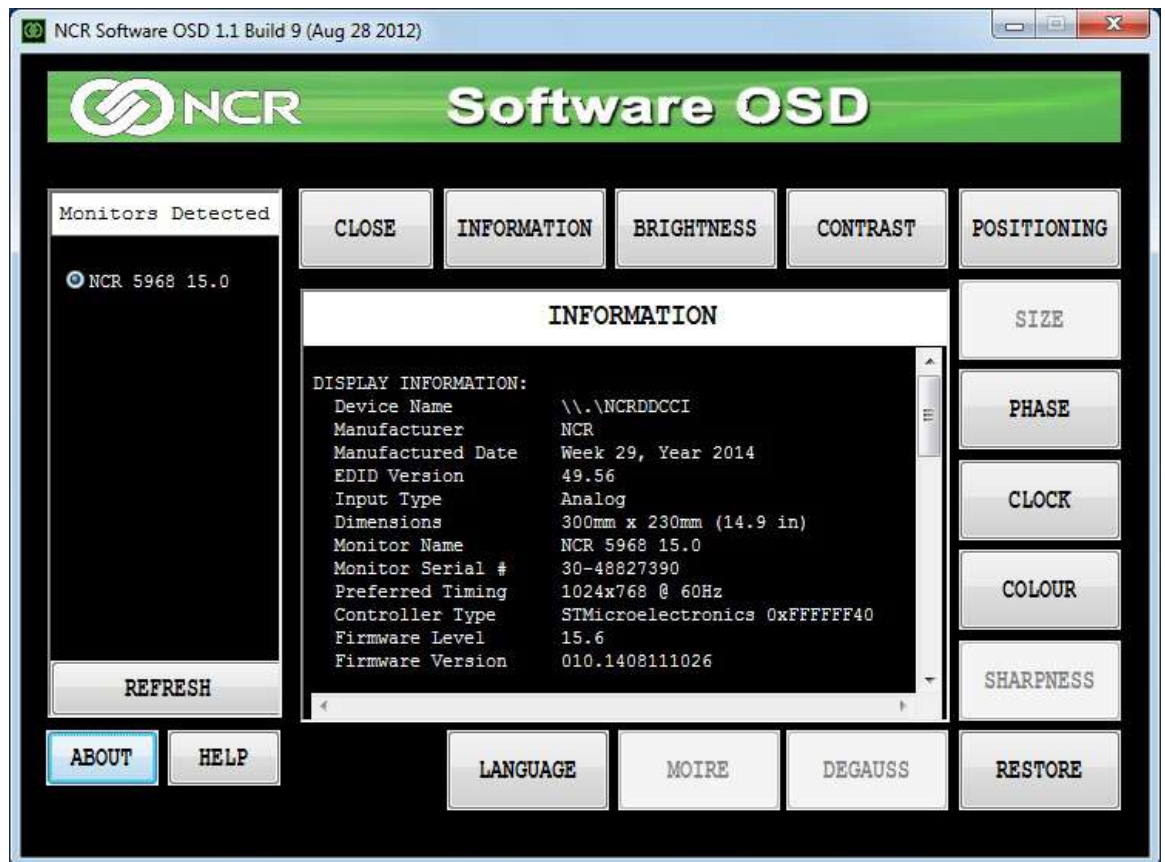

Monitors Detected Panel

This panel lists all the monitors connected to the system. If more than one monitor is connected, the first monitor is selected by default.

Center Panel

The Center Panel displays information pertaining the selected control.

Control Buttons

The Control Buttons show the available features that can be modified. Unavailable features are grayed out.

Refresh

Refreshes data in the Monitors Detected panel (OSD does not auto detect). Use this button after connecting a new monitor to refresh the data.

About

Displays a brief description of the utility.

Help

Opens the Help File.

Close

Closes the OSD application.

Information

Provides information about the selected monitor. Information includes:

- Device manufacturer
- Date manufactured
- EDID version
- Input type
- Dimensions
- Monitor name
- Monitor serial number
- Preferred timing
- Controller type
- Firmware level
- Firmware version (for Dynamo display only)
- Display mode (for Dynamo display only)
- Timing Report
 - Horizontal frequency
 - Vertical frequency
 - Timing status
- Raw EDID
- Raw capabilities string (CAPS)

Brightness

Provides tools for adjusting Display brightness settings.

Contrast

Provides tools for adjusting Display contrast settings.

Positioning

Provides tools for gradually moving the image on the Display to a specific region (either left, right, up, or down).

Size

Provides tools for increasing or decreasing the height and width of the image on the Display.

Phase

Provides tools for increasing or decreasing the phase shift of the sampling clock.

Clock

Provides tools for increasing or decreasing the video sampling clock frequency.

Colour

Provides tools for adjusting Display color settings.

Sharpness

Provides tools for increasing or decreasing the sharpness settings of the Display.

Restore

Provides the following functions:

- Auto Setup — sets horizontal position, vertical position, clock and phase
- Auto Color — sets red/green/blue gain
- Factory Defaults — restores all factory defaults including brightness, contrast, and color
- Brightness/Contrast — restores factory defaults for brightness and contrast
- Geometry Settings — restores factory defaults for geometry settings such as horizontal position and vertical position
- Colour Settings — restores factory defaults for colour settings

Degauss

Provides tools for CRT display to perform a degauss cycle.

Moire

Provides tools for increasing or decreasing the vertical or horizontal moiré picture cancellation.

Language

Provides listing of the supported languages and permits changing the OSD language.

Display Adjustment Procedures

The adjustment procedures are similar for most features. The color adjustment shown below is an example.

1. Select the **Colour** button.
2. The default Colour Settings menu has the 6500K radio button selected. To activate the color slides select **User1**.

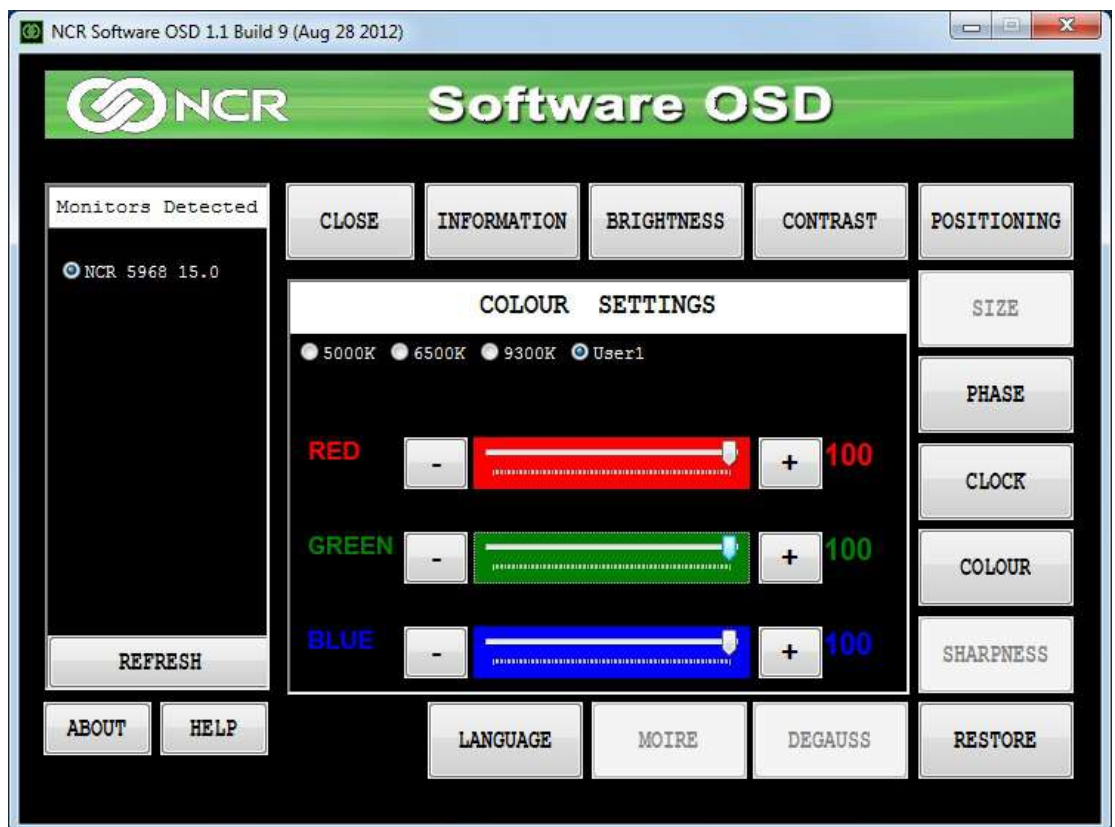

3. Drag the slider to the right to increase the value of the property or to the left to decrease it. Alternatively, you can click on the "+" and "-" buttons.

Resetting Factory Defaults

Should the need arise the display settings can be reset to the factory defaults.

1. Select the **Restore** button.

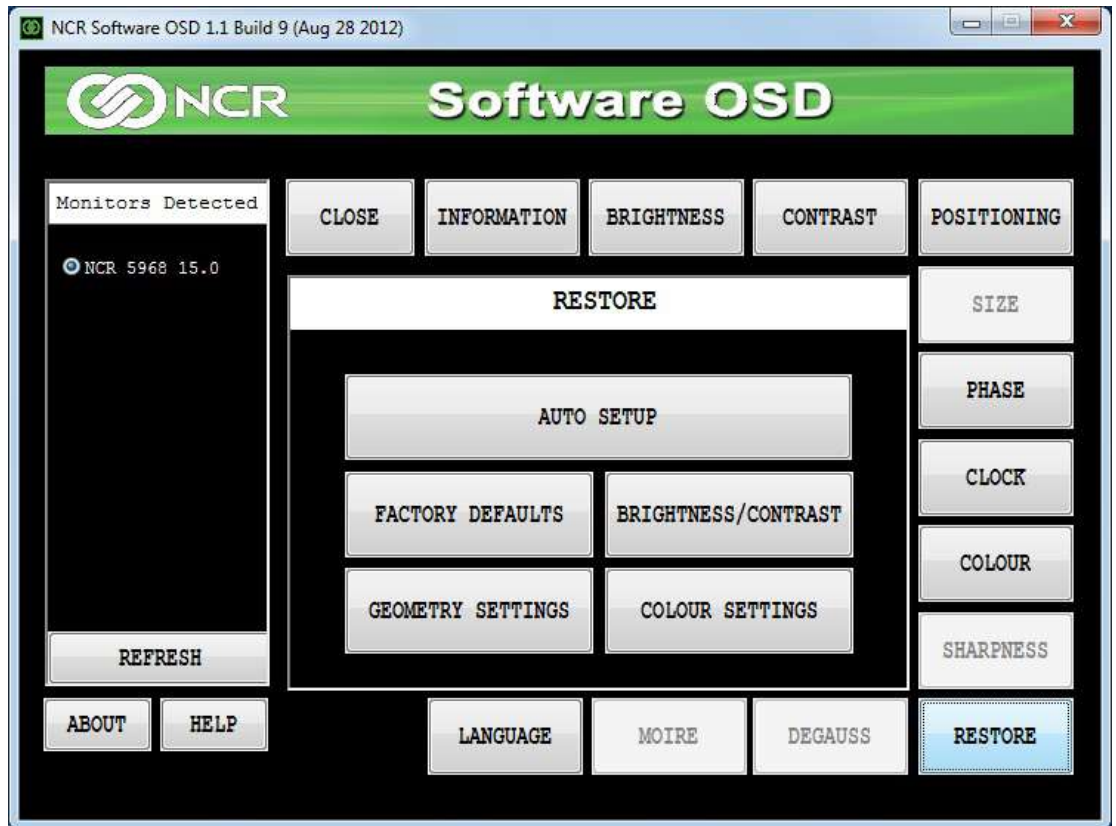

2. All settings or just specific groups can be reset. Select the button of choice in the *Restore* window:
 - Auto Setup — re-positions the window in the center of the display
 - Factory Defaults — resets everything to the factory defaults
 - Brightness/Contrast — resets the brightness and contrast settings only
 - Color Settings — resets the color settings only

Running the Utility (Console Version)

1. Unzip the downloaded application to a folder of your choice on the target system.
2. In the unzipped folder, navigate to the OSD executable.

Example: (32-Bit version)

```
NCR_Software_OSD_Console_x86_V2.1.7.1 >> x86
```

3. Open a Command Line dialog window.
4. From the Command Line dialog, navigate to the OSD executable (*.exe) file.
5. Execute the file to start the application.

```
NCR_Software_OSD_Console_x86.exe >> [Enter]
```

A list of the available script command options are displayed, followed by several example scripts. If you need further assistance with creating scripts please contact your NCR representative for help.